



SWITCHGEAR

4G cam switches





GENERAL INFORMATION

4G-series cam switches are low voltage switches, designed according to the latest knowledge about switchgear and using the achievements of modern engineering. Only high quality insulation and contact materials have been used in these products. Basic components and units are standardized and mass-produced, making it possible to make switches performing any switching programs, and short delivery terms.

Switches can be produced in many versions and have various applications. They conform all requirements for low voltage switches in industry, mining, shipbuilding, etc. They can be used as hand-operated switches in transformer stations, control switchboxes and boards, switchgears made of cast iron or other metals, welding machines and similar devices.

4G series switches are characterized by small external dimensions, powerful switching capabilities, long contact life and high mechanical stability, and resistance to short-lasting overloads. When additionally protected with fuses, they are also resistant to dynamic effects of short-circuit currents.

APPLICATION

Cam switches can be used in main and auxiliary circuits, especially:

- as switches for electric motors for switching and controlling the drives with single- and three-phase motors, as star-delta switches, reversing switches and switches for changing the rotational speed, etc.,
- in auxiliary, controlling, signalling and measuring circuits, manufactured according to the required switching program,
- as breaker switches, change-over switches and tap switches, for example for transformers and electric welding machines,
- as switchgroups, for example to connect resistors and heating elements,
- as change-over switches working as push-buttons with automatic returning to an off position,
- as switch disconnectors.

CONFORMITY WITH STANDARDS

4G-series cam switches fully comply with the requirements of the following standards: 93/E-06150/10, 93/E-06150/30, IEC 947-1, IEC 947-3.

These switches have Recognition Certificate of the Polish Register of Shipping, and CE Declaration of conformity of the European directive 73/23/EEC.

DIVISION

Basic division of switches and their marking is based on the rated current. Further division, based on external dimensions of the switches, enables to distinguish three groups characterized by overall dimensions. Each group has the same knobs, front plates and spacing for mounting holes.

Table 139. DIVISION INTO GROUPS

Group	A0		A1		A2		A3
Switch type	4G10	4G16	4G25	4G40	4G63	4G80	4G100
Rated current I_n [A]	10	16	25	40	63	80	100

DESIGN

Depending on the switching program, every cam switch consists of a certain number of switching elements, which can be easily assembled together. Switching elements' bodies are made of plastics based on melamine, especially resistant to the effects related to creep currents and electric arcs.

A switching element has one or two current circuits arranged at the angle of 180° and equipped with contact with a double contact gap. Each of them consists of two stationary contacts and one movable contact bridge. The contact bridge is switched on (pressed) by contact springs, and opened by a cam inside the switching element. The cams in individual switching elements are firmly coupled together, ensuring practically simultaneous switching (on and off) of all contacts. Thanks to the double gap contact assembly and contact tips made of special alloy containing silver and very resistant to effects of an electric arc, high switching capabilities and contact life have been obtained. Good clicking mechanism of a motion work ensures unfailing switching of moving contacts in respective fixed positions. The power springs of the clicking mechanism are different, depending on the number of the switching elements. According to individual requirements, cam switches can be made with the switching angles given in table 2.

Table 140. CONNECTION ANGLES

Group		A0	A1	A2	A3	maximum number of handle positions
Connection angle	30°	•	•	•	•	12
	45°	•	•	•		8
	60°	•	•	•	•	6
	90°	•	•	•	•	4

Special stops are used to fix proper positions. Switching elements, driving mechanism and a rear plate (mounting plate) are connected into one unit with insulating bolts.

Special versions of cam switches can have more than 12 switching elements.

SUB-ASSEMBLIES

Front plate

Complete front plate consists of:

- a front plate with a place with black frame for a text; - an indicating plate cover (transparent),
- indicating plate (under the cover, standard version is white with black signs).

According to requirements, this plate can be black, yellow or silver.

HANDLE

The handle is used to control the switch. Black is a standard colour. According to requirements, the handles can be supplied in red colour.

Table 141. HANDLE TYPES



Group	A0	A1	A2	A3
	R012 red R014 black (standard)	R112 red R114 black (standard)	R212 red R214 black (standard)	R312 red R314 black (standard)
		R122 red R124 black	R222 red R224 black	R322 red R324 black

Table 142. TECHNICAL DATA

Parameters		switch type												
		4G10	4G16	4G25	4G40	4G63	4G80	4G100	4G200	4G400	4G630	4G800	4G1200	
Rated insulation voltage U_i	V	690	690	690	690	690	690	690	690	690	690	690	690	
Rated impulse withstand voltage U_{imp}	kV	4	4	4	6	6	6	6	8	8	8	8	8	
Rated thermal current I_{th}	A	16	20	25	50	63	80	125	200	400	630	800	1200	
Short-circuit protection Rated breaking capacity of fuse links with high breaking capacity	10 kA _{sk}	A	–	25	25	50	63	80	125	200	400	630	2x400	2x630
	25 kA _{sk}	A	–	25	25	50	63	80	125	160	315	500	2x400	2x630
	40 kA _{sk}	A	–	25	25	50	63	80	125	160	315	400	500	2x400
	63 kA _{sk}	A	–	25	25	36	50	63	100	160	250	355	400	630
75 kA _{sk}	A	–	25	25	36	50	63	100						
Mechanical durability (number of cycles)		3x10 ⁶	3x10 ⁶	3x10 ⁶	3x10 ⁶	3x10 ⁶	3x10 ⁶	3x10 ⁶	3x10 ⁶	2x10 ⁵	2x10 ⁵	2x10 ⁵	2x10 ⁵	2x10 ⁵
Terminal bolts Maximum cross-section of connecting conductors	mm ²	M3 2 x 2,5	M4 2 x 4	M4 2 x 6	M5 2 x 10	M5 2 x 10	M6 25	2 x M6 50	M6 –	M10 –	M12 –	M16 –	M16 –	
Short duration load capacity	1 s	A	220	430	690	920	1600	1600	2600	3300	6500	9500	12000	18000
	10 s	A	70	145	240	290	600	650	850	1100	2000	3000	4000	6100
	30 s	A	40	90	160	200	375	400	500	640	1200	1800	2400	3500
	60 s	A	30	75	125	155	285	300	360	460	850	1250	1600	2450
Breaking capacity	660 V - cosφ = 0,65	A	–	190	–	–	–	–	–	640	–	–	–	–
	660 V - cosφ = 0,35	A	–	–	250	490	500	500	650	–	–	–	–	–
	600 V - cosφ = 0,35	A	–	200	260	500	610	610	–	–	–	–	–	–
	500 V - cosφ = 0,35	A	100 ¹⁾	–	–	–	–	–	900	900	–	–	–	–
	500 V - cosφ = 0,75	A	–	–	–	–	–	–	–	–	1100	1100	1200	1800
Switch disconnectors Utilization category AC2 Rated power of three-phase loads	3 x 220 V~	kW	5,2	7	9	14	23	29	37	72	150	150	150	150
	3 x 380 V~	kW	9	12,5	15,5	24	39	50	63	125	260	260	260	260
	3 x 500 V~	kW	11,8	17	20	33	52	66	84	165	340	340	340	340
	3 x 660 V~	kW	15,5	22	27	43	69	86	110	210	400	400	400	400
Switch disconnectors for motors Utilization category AC3, AC23 Rated power of three-phase motors	3 x 220 V~	kW	3	4,5	7,5	12,5	18,5	21	–	27,5	27,5	27,5	27,5	27,5
	3 x 380 V~	kW	5	8	13	21	32	37	–	47	47	47	47	47
	3 x 500 V~	kW	6	11	17	27	42	48	–	62	62	62	62	62
	3 x 660 V~	kW	6	11	17	27	55	60	–	80	80	80	80	80
Switch disconnectors for motors Utilization category AC23 Rated power of three-phase motors	3 x 220 V~	kW	–	–	–	–	–	–	27,5	27,5	27,5	27,5	27,5	27,5
	3 x 380 V~	kW	–	–	–	–	–	–	47	47	47	47	47	47
	3 x 500 V~	kW	–	–	–	–	–	–	62	62	62	62	62	62
	3 x 660 V~	kW	–	–	–	–	–	–	80	80	80	80	80	80
Switch disconnectors for motors, category of utility AC3, AC23 (30 connections/h). Rated power of one-phase (dipolar) motors.	110 V~	kW	0,8	1,3	2,1	3,6	5,3	6	–	–	–	–	–	–
	220 V~	kW	1,7	2,6	4,3	7,2	10,6	12,1	–	–	–	–	–	–
	380 V~	kW	2,8	4,6	7,5	12	18,5	21,1	–	–	–	–	–	–
Auxiliary switch disconnectors Utilization category AC14 Rated switching current I_e (1 pole)	110 V~	A	11	20	25	50	63	72	–	–	–	–	–	–
	220 V~	A	8	20	25	40	50	50	–	–	–	–	–	–
	380 V~	A	3,5	16	20	40	45	45	–	–	–	–	–	–
	660 V~	A	2,5	8	8,5	10	10	10	–	–	–	–	–	–
Type of operation	–	Continuous duty												

1) - cosφ = 0,65

BREAKING CAPACITY FOR DIRECT CURRENT

Breaking capacity for direct current operation depends on current intensity, voltage and inductance.

Time constant $T = L/R$ represents inductance values in a current circuit.

$T = 1$ ms – active power or lightly inductive power predominates, for example resistance furnaces.

$T = 15$ ms – inductive power predominates, for example relay coils. For direct current and voltage above 60 V, switch contacts must be connected in parallel to obtain higher breaking capacity.

Table 143. RATED BREAKING CAPACITY OF ONE CONTACT

Switch type	rated breaking capacity of one contact											
	24 V		60 V		110 V		220 V		440 V		600 V	
	T = 1 ms	T = 15 ms	T = 1 ms	T = 15 ms	T = 1 ms	T = 15 ms	T = 1 ms	T = 15 ms	T = 1 ms	T = 15 ms	T = 1 ms	T = 15 ms
4G10	40	40	40	20	17	3	1,1	0,5	0,5	0,2	0,5	0,1
4G16	100	100	38	18	5,5	3	0,95	0,4	0,5	0,25	0,3	0,2
4G25	100	100	38	18	5,5	3	0,95	0,4	0,5	0,25	0,3	0,2
4G40	252	252	95	40	15	3,5	1,2	0,4	0,6	0,25	0,45	0,2
4G63	252	252	95	40	15	3,5	1,2	0,4	0,6	0,25	0,45	0,2
4G100	800	800	400	400	35	7,5	2,5	0,75	0,9	0,3	0,5	0,25

Table 106 shows a number of contacts which can be connected in series for rated making currents at specific constant voltages for category of utility DC 1.

Table 144. NUMBER OF CONTACTS CONNECTED IN SERIES

Switch type	number of contacts connected in series			
	110 V	220 V	440 V	600 V
4G10	1	3	6	8
4G16	2	4	6	9
4G25	2	4	6	9
4G40	2	3	6	9
4G63	2	4	6	9
4G100	2	3	6	–

DC1 – main noninductive or low voltage load

$T = 1$ ms breaking capacity $I = 1,5 I_e$

Note: Breaking capacity for a 4G25 switch with two contacts connected in series is 2A at 220V; $T = 15$ ms.

In table 107 the rated making current values (I_e) for category of utility DC 11 (according to EC 337-1, 337-1A) have been shown.

Table 145. RATED SWITCHING CURRENT

Switch type	Rated switching current I_e [A]					
	24 V	60 V	110 V	220 V	440 V	600 V
4G10	10	2	1	0,27	0,16	0,14
4G16	20	2,2	1	0,3	0,22	0,16
4G25	25	2,2	1	0,3	0,22	0,16
4G40	50	5	2	0,4	0,23	0,2
4G63	63	5	2	0,4	0,23	0,2

**SWITCHING PROGRAMS**

Switching program	diagram number	page	Switching program	diagram number	page		
switch disconnectors with "0" (0-1) position			multiposition switches with "0" (0-1-2...) position				
1-pole	90	191	1-pole	7-position	111		
2-pole	91			8-position	112		
3-pole	10			9-position	113		
multi-pole	92			10-position	114		
	100			11-position	115		
	528			12-position	116		
	659						
switch disconnectors with quick-connecting contacts (0-1)			2-pole				
with 30° contact lead	1-pole	270	2-pole	3-position	123		
	2-pole	271		4-position	124		
	3-pole	63		5-position	125		
with 30° contact lead on three contacts and 60° on one contact	4-pole	272		191	6-position	126	
					5-position	127	
with 30° contact lead on three contacts and 60° on two contacts	5-pole	273			7-position	127	
					8-position	128	
with 30° contact lead	6-pole	274			9-position	129	
					10-position	130	
switches with "0" (1-0-2) position					3-pole		
1-pole	51	192			3-pole	11-position	131
2-pole	52					12-position	132
3-pole	53		3-position			135	
multi-pole	75		4-position			136	
	76		5-position			137	
	77		6-position	138			
	78		7-position	139			
	79		8-position	140			
	80						
switches for current transformers (1-2)			multi-pole				
	57		192	multi-pole	3-position	145	
switches without "0" (1-2) position			4-position		146		
1-pole	54	193	5-position		147		
2-pole	55		6-position		148		
3-pole	56		3-position		151		
multi-pole	69		4-position		152		
	70		5-position		153		
	71		3-position		156		
	72		4-position		157		
	73		5-position		158		
	74		3-position		160		
multiposition switches with "0" (0-1-2...) position			multiposition switches without "0" position				
1-pole	3-position		107	1-pole	3-position	82	
	4-position		108		4-position	83	
	5-position	109	5-position		84		
	6-position	110	6-position		85		
193			196				
194			197				
195			198				
196			199				
197			200				
198			201				
199			202				
200			203				
201			204				
202			205				
203			206				
204			207				
205			208				
206			209				
207			210				
208			211				
209			212				
210			213				
211			214				
212			215				
213			216				
214			217				
215			218				
216			219				
217			220				
218			221				
219			222				
220			223				
221			224				
222			225				
223			226				
224			227				
225			228				
226			229				
227			230				
228			231				
229			232				
230			233				
231			234				
232			235				
233			236				
234			237				
235			238				
236			239				
237			240				
238			241				
239			242				
240			243				
241			244				
242			245				
243			246				
244			247				
245			248				
246			249				
247			250				
248			251				
249			252				
250			253				
251			254				
252			255				
253			256				
254			257				
255			258				
256			259				
257			260				
258			261				
259			262				
260			263				
261			264				
262			265				
263			266				
264			267				
265			268				
266			269				
267			270				
268			271				
269			272				
270			273				
271			274				
272			275				
273			276				
274			277				
275			278				
276			279				
277			280				
278			281				
279			282				
280			283				
281			284				
282			285				
283			286				
284			287				
285			288				
286			289				
287			290				
288			291				
289			292				
290			293				
291			294				
292			295				
293			296				
294			297				
295			298				
296			299				
297			300				
298			301				
299			302				
300			303				
301			304				
302			305				
303			306				
304			307				
305			308				
306			309				
307			310				
308			311				
309			312				
310			313				
311			314				
312			315				
313			316				
314			317				
315			318				
316			319				
317			320				
318			321				
319			322				
320			323				
321			324				
322			325				
323			326				
324			327				
325			328				
326			329				
327			330				
328			331				
329			332				
330			333				
331			334				
332			335				
333			336				
334			337				
335			338				
336			339				
337			340				
338			341				
339			342				
340			343				
341			344				
342			345				
343			346				
344			347				
345			348				
346			349				
347			350				
348			351				
349			352				
350			353				
351			354				
352			355				
353			356				
354			357				
355			358				
356			359				
357			360				
358			361				
359			362				
360			363				
361			364				
362			365				
363			366				
364			367				
365			368				
366			369				
367			370				
368			371				
369			372				
370			373				
371			374				
372			375				
373			376				
374			377				
375			378				
376			379				
377			380				
378			381				
379			382				
380			383				
381			384				
382			385				
383			386				
384			387				
385			388				
386			389				
387			390				
388			391				
389			392				
390			393				
391			394				
392			395				
393			396				
394			397				
395			398				
396			399				
397			400				
398			401				
399			402				
400			403				
401			404				
402			405				
403			406				
404			407				
405			408				
406			409				
407			410				
408			411				
409			412				
410			413				
411			414				
412			415				
413			416				
414			417				
415			418				
416			419				
417			420				
418			421				
419			422				
420			423				
421			424				
422			425				
423			426				
424			427				
425			428				
426			429				
427			430				
428			431				
429			432				
430			433				
431			434				
432			435				
433			436				
434			437				
435			438				
436			439				
437			440				
438			441				
439			442				
440			443				
441			444				
442			445				
443			446				
444			447				
445			448				
446			449				
447			450				
448			451				
449			452				
450			453				
451			454				
452			455				
453							

Switching program	diagram number	page
multiposition switches without "0" position		
2-pole	3-position	86
	4-position	87
	5-position	88
	6-position	89
	7-position	117
	8-position	118
	9-position	119
	10-position	120
	11-position	121
	12-position	122
3-pole	3-position	93
	4-position	94
	5-position	95
	6-position	96
	7-position	133
	8-position	134
multi-pole	3-position	141
	4-position	142
	5-position	143
	6-position	144
	3-position	149
	4-position	150
	3-position	154
	4-position	155
	3-position	159
	3-position	162
switchgroups with "0" position		
1-pole	2-group.	251
	3-group.	254
2-pole	2-group.	252
	3-group.	255
3-pole	2-group.	253
	3-group.	256
serial switches		
1-pole		257
2-pole		258
3-pole		259
serial-parallel switches		
2-pole		260
measurement switches for voltage and current ammeter switches		
phase measurement	L1-L2-L3	58
phase measurement	0-1-2-3	97
phase measurement with grounding	0-1-2-3	98
serial-parallel switches		
3 phase-to-phase voltages + phase voltage		60

Switching program	diagram number	page
voltmeter switches without "0" position		
3 phase voltages	68	204
3 phase-to-phase voltages	67	
3 phase-to-phase voltages + 3 phase voltages	66	
switches with an automatic return to initial position		
switch with a function of left - right pushbuttons switch with "0" position (1-0-2) return to "0" from both sides	210	204
1-pole	201	
2-pole	202	
3-pole	203	
switches without "0" position		
1 normally closed contact + 1 normally open contact	204	205
2 normally closed contacts + 2 normally open contacts	205	
3 normally closed contacts + 3 normally open contacts	206	
to control a contactor – 1 normally open contact (turn right) and 1 normally closed contact (turn left)	207	
1 normally open contact and 1 normally closed contact, when turning left and right	208	
2 normally open contacts and 2 normally closed contacts, when turning left and right	209	
switch disconnectors for motor controlling, star-delta switch disconnectors		
basic version	12	205
Y/ Δ back from Y to 0	28	
with counter-current braking back from Y to 0	29	206
as a voltage switch	30	
for operation with contactor	31	
bidirectional (left-right)	21	
switch disconnectors in a Dahlander's system		
dipolar Δ -0-YY	13	206
dipolar 0- Δ -YY	19	
dipolar bidirectional YY- Δ -0- Δ -YY	20	
dipolar and contactor controlling	32	
switch disconnectors for two-winding motors		
0-1-2	22	207
bidirectional	23	
to control the contactors	33	
switch disconnectors for three-speed motors		
2 windings 0- Δ -YY-Y (with 3 speeds in a Dahlander's system)	34	207
2 windings 0- Δ -YY-Y (1 and 2 speeds in a Dahlander's system)	35	208
2 windings 0- Δ -YY-Y (2 and 3 speeds in a Dahlander's system)	36	
reversing switches		
2-pole		24
2-pole, return to "0" position		25
3-pole		11
3-pole, return to "0" position		26
to control a contactor		27
starting switches for 1-phase motors		15



AN ORDER EXAMPLE

4G25 - 10 - U S5 R112

switch type determined according to the rated current, selection in accordance with table 121

diagram number specified in the switching program

version:
U – switch to be built-in
OU – switch to be mounted in a housing
PK – switch in a plastic case

special version, its symbol can be added to the description of type

knob and handle version and colour according to table 123

NOTES:

- every order on devices for rated current 100A requires arrangements with the manufacturer related to the technical details and delivery date,
- devices in PK housings can be made only for those switching programs which require not more than four segments (protection class IP 55/IP 65),

EXPRES SERVICE 24 h or 48 h - There is the ability to perform cam switches in 24 or 48 h (additional fee)

STANDARD CONNECTION DIAGRAMS

Diagram number	Number of poles	Rated switching current	Rated voltage	Number of packs	Symbol Article No.	Handle	Protection degree IP from the front	Maximum conductor cross-section [mm ²]	Installation
Switch disconnecter with "0" (0-1) position									
	1	10	690	1	4G10-90-U 63-840390-011	R014	IP40	2 x 2,5	to be mounted behind the panel
	1	16	690	1	4G16-90-U 63-840390-021	R114	IP40	2 x 4	
	1	25	690	1	4G25-90-U 63-840390-031	R114	IP40	2 x 6	
	1	10	690	1	4G10-90-PK 63-840392-011	R014	IP55	2 x 2,5	in a housing
	1	25	690	1	4G10-90-PK IP65 63-840392-111	R114	IP65	2 x 6	
	1	16	690	1	4G16-90-PK 63-840392-021	R114	IP55	2 x 4	
	1	25	690	1	4G25-90-PK 63-840392-031	R114	IP55	2 x 6	
	2	10	690	1	4G10-91-U 63-840393-011	R014	IP40	2 x 2,5	to be mounted behind the panel
	2	16	690	1	4G16-91-U 63-840393-021	R114	IP40	2 x 4	
	2	10	690	1	4G10-91-PK 63-840395-011	R014	IP55	2 x 2,5	
	2	25	690	1	4G10-91-PK IP65 63-840395-111	R114	IP65	2 x 6	in a housing
	2	16	690	1	4G16-91-PK 63-840395-021	R114	IP55	2 x 4	
	2	25	690	1	4G25-91-PK 63-840395-031	R114	IP55	2 x 6	

* see dimensions on pages 191 - 194

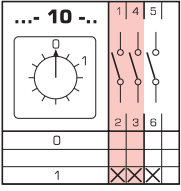
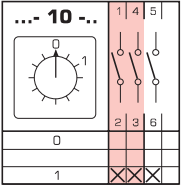
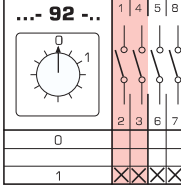
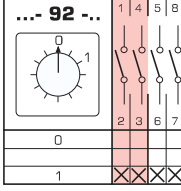
Diagram number	Number of poles	Rated switching current	Rated voltage	Number of packs	Symbol Article No.	Handle	Protection degree IP from the front	Maximum conductor cross-section [mm ²]	Installation		
Switch disconnecter with "0" (0-1) position											
	3	10	690	2	4G10-10-U 63-840304-011	R014	IP40	2 x 2,5	to be mounted behind the panel		
	3	16	690	2	4G16-10-U 63-840304-021	R114	IP40	2 x 4			
	3	25	690	2	4G25-10-U 63-840304-031	R114	IP40	2 x 6			
	3	40	690	2	4G40-10-U 63-840304-041	R214	IP40	2 x 10			
	3	63	690	2	4G63-10-U 63-840304-051	R214	IP40	2 x 10			
	3	80	690	2	4G80-10-U 63-840304-061	R214	IP40	25			
		3	10	690	2	4G10-10-PK 63-840306-011	R014	IP55	2 x 2,5	in a housing	
		3	10	690	2	4G10-10-PK IP65 63-840306-111	R014	IP65	2 x 2,5		
		3	16	690	2	4G16-10-PK 63-840306-021	R114	IP55	2 x 4		
		3	25	690	2	4G25-10-PK 63-840306-031	R114	IP55	2 x 6		
		3	40	690	2	4G40-10-PK 63-840306-041	R214	IP55	2 x 10		
		3	63	690	2	4G63-10-PK 63-840306-051	R214	IP55	2 x 10		
		3	80	690	2	4G80-10-PK 63-840306-061	R214	IP55	25		
			4	10	690	2	4G10-92-U 63-840396-011	R014	IP40		2 x 2,5
4			16	690	2	4G16-92-U 63-840396-021	R114	IP40	2 x 4		
4			25	690	2	4G25-92-U 63-840396-031	R114	IP40	2 x 6		
4	40		690	2	4G40-92-U 63-840396-041	R214	IP40	2 x 10			
4	63		690	2	4G63-92-U 63-840396-051	R214	IP40	2 x 10			
4	80		690	2	4G80-92-U 63-840396-061	R214	IP40	25			
	4		10	690	2	4G10-92-PK 63-840398-011	R014	IP55	2 x 2,5	in a housing	
	4		10	690	2	4G10-92-PK IP65 63-840398-111	R014	IP65	2 x 2,5		
	4		16	690	2	4G16-92-PK 63-840398-021	R114	IP55	2 x 4		
	4		25	690	2	4G25-92-PK 63-840398-031	R114	IP55	2 x 6		
	4		40	690	2	4G40-92-PK 63-840398-041	R214	IP55	2 x 10		
	4		63	690	2	4G63-92-PK 63-840398-051	R214	IP55	2 x 10		
	4		80	690	2	4G80-92-PK 63-840398-061	R214	IP55	25		

* see dimensions on pages 191 - 194



Diagram number	Number of poles	Rated switching current	Rated voltage	Number of packs	Symbol Article No.	Handle	Protection degree IP from the front	Maximum conductor cross-section [mm ²]	Installation
"mains-unit" switch (1-0-2)									
	1	10	690	1	4G10-51-U 63-840338-011	R014	IP40	2 x 2,5	to be mounted behind the panel
	1	10	690	1	4G10-51-PK 63-840340-011	R014	IP55	2 x 2,5	in a housing
	1	10	690	1	4G10-51-PKIP65 63-840340-111	R014	IP65	2 x 2,5	
	2	10	690	2	4G10-52-U 63-840341-011	R014	IP40	2 x 2,5	to be mounted behind the panel
	"rotation direction change" switch (L-0-P)								
	3	10	690	3	4G10-53-U 63-840343-011	R014	IP40	2 x 2,5	to be mounted behind the panel
	3	16	690	3	4G16-53-U 63-840343-021	R114	IP40	2 x 4	
	3	25	690	3	4G25-53-U 63-840343-031	R114	IP40	2 x 6	
	3	40	690	3	4G40-53-U 63-840343-041	R214	IP40	2 x 10	
	3	63	690	3	4G63-53-U 63-840343-051	R214	IP40	2 x 10	
	3	80	690	3	4G80-53-U 63-840343-061	R214	IP40	25	
	3	10	690	3	4G10-53-PK 63-840345-011	R014	IP55	2 x 2,5	in a housing
	3	10	690	3	4G10-53-PKIP65 63-840345-111	R014	IP65	2 x 2,5	
	3	16	690	3	4G16-53-PK 63-840345-021	R114	IP55	2 x 4	
	3	25	690	3	4G25-53-PK 63-840345-031	R114	IP55	2 x 6	
	3	40	690	3	4G40-53-PK 63-840345-041	R214	IP55	2 x 10	
	3	63	690	3	4G63-53-PK 63-840345-051	R214	IP55	2 x 10	
	3	80	690	3	4G80-53-PK 63-840345-061	R214	IP55	25	
"rotation direction change" switch (L-0-P)									
	3	10	690	3	4G10-11-U 63-840307-011	R014	IP40	2 x 2,5	to be mounted behind the panel
	3	16	690	3	4G16-11-U 63-840307-021	R114	IP40	2 x 4	
	3	25	690	3	4G25-11-U 63-840307-031	R114	IP40	2 x 6	
	3	40	690	3	4G40-11-U 63-840307-041	R214	IP40	2 x 10	
	3	63	690	3	4G63-11-U 63-840307-051	R214	IP40	2 x 10	
	3	80	690	3	4G80-11-U 63-840307-061	R214	IP40	25	

* see dimensions on pages 191 - 194

Diagram number	Number of poles	Rated switching current	Rated voltage	Number of packs	Symbol Article No.	Handle	Protection degree IP from the front	Maximum conductor cross-section [mm ²]	Installation			
"rotation direction change" switch (L-0-P)												
	3	10	690	3	4G10-11-PK 63-840309-011	R014	IP55	2 x 2,5	in a housing			
	3	10	690	3	4G10-11-PK IP65 63-840309-111	R014	IP65	2 x 2,5				
	3	16	690	3	4G16-11-PK 63-840309-021	R114	IP55	2 x 4				
	3	25	690	3	4G25-11-PK 63-840309-031	R114	IP55	2 x 6				
	3	40	690	3	4G40-11-PK 63-840309-041	R214	IP55	2 x 10				
	3	63	690	3	4G63-11-PK 63-840309-051	R214	IP55	2 x 10				
	3	80	690	3	4G80-11-PK 63-840309-06	R214	IP55	25				
"star-delta" (Y-0-Δ) motor control switch												
	3	10	690	4	4G10-12-U 63-840310-011	R014	IP40	2 x 2,5	to be mounted behind the panel			
	3	16	690	4	4G16-12-U 63-840310-021	R114	IP40	2 x 4				
	3	25	690	4	4G25-12-U 63-840310-031	R114	IP40	2 x 6				
	3	40	690	4	4G40-12-U 63-840310-041	R214	IP40	2 x 10				
	3	63	690	4	4G63-12-U 63-840310-051	R214	IP40	2 x 10				
	3	80	690	4	4G80-12-U 63-840310-061	R214	IP40	25				
	<td>3</td> <td>10</td> <td>690</td> <td>4</td> <td>4G10-12-PK 63-840591-011</td> <td>R014</td> <td>IP55</td> <td>2 x 2,5</td> <td rowspan="10" style="text-align: center;">in a housing</td>	3	10	690	4	4G10-12-PK 63-840591-011	R014	IP55	2 x 2,5	in a housing		
		3	10	690	4	4G10-12-PK IP65 63-840591-111	R014	IP65	2 x 2,5			
		3	16	690	4	4G16-12-PK 63-840591-021	R114	IP55	2 x 4			
		3	25	690	4	4G25-12-PK 63-840591-031	R114	IP55	2 x 6			
		3	40	690	4	4G40-12-PK 63-840591-041	R214	IP55	2 x 10			
		3	63	690	4	4G63-12-PK 63-840591-051	R214	IP55	2 x 10			
		3	80	690	4	4G80-12-PK 63-840591-061	R214	IP55	25			
		voltmeter switch (L3L1, L2L3, L1L2 - 0 - L1N, L2N, L3N)										
			4	10	690	3	4G10-66-U 63-840360-011	R014	IP40		2 x 2,5	to be mounted behind the panel
		switch for forklift trucks(1-0-2)										
<p>Styk (zacisk 1-2) należy włączyć w obwód sterowania cewki stycznika.</p>	5	80	690	6	4G80-770-U 63-841838-061	R214	IP40	25	to be mounted behind the panel			

* see dimensions on pages 191 - 194



Diagram number	Number of poles	Rated switching current	Rated voltage	Number of packs	Symbol Article No.	Handle	Protection degree IP from the front	Maximum conductor cross-section [mm ²]	Installation
main (emergency) switch connectors									
	3	16	690	2	4G16-10-PK S6 63-241669-021	R114	IP55	2 x 4	in a housing
	3	16	690	2	4G16-10-OU S8 S25 63-241670-021	R114	IP40	2 x 4	to be mounted behind the panel
	3	16	690	2	4G16-10-U S25 63-241671-021	R114	IP40	2 x 4	
	3	25	690	2	4G25-10-OU S8 S25 63-241672-031	R114	IP40	2 x 6	in a housing
	3	25	690	2	4G25-10-PK S6 63-241673-031	R114	IP55	2 x 6	
	3	25	690	2	4G25-10-U S25 63-241674-031	R114	IP40	2 x 6	to be mounted behind the panel
	3	40	690	2	4G40-10-OU S8 S25 63-241675-041	R214	IP40	2 x 10	in a housing
	3	40	690	2	4G40-10-PK S6 63-241676-041	R214	IP55	2 x 10	
	3	40	690	2	4G40-10-U S25 63-241677-041	R214	IP40	2 x 10	to be mounted behind the panel
	3	63	690	2	4G63-10-U S25 63-241678-051	R214	IP40	2 x 10	
	3	80	690	2	4G80-10-U S6 63-241858-061	R214	IP40	25	
switches (1-2)									
	1	10	690	1	4G10-54-U 63-840346-011	R014	IP40	2 x 2,5	to be mounted behind the panel
	1	10	690	1	4G10-54-PK 63-840347-011	R014	IP55	2 x 2,5	in a housing
	1	10	690	1	4G10-54-PK IP65 63-840347-111	R014	IP65	2 x 2,5	
	2	10	690	2	4G10-55-U 63-840348-011	R014	IP40	2 x 2,5	to be mounted behind the panel
	2	10	690	2	4G10-55--PK 63-840350-011	R014	IP55	2 x 2,5	in a housing
	2	10	690	2	4G10-55-PK IP65 63-840350-111	R014	IP65	2 x 2,5	
	3	10	690	3	4G10-56-PK konfigurator	R014	IP40	2 x 2,5	to be mounted behind the panel
	4	10	690	4	4G10-69-U 63-840367-011	R014	IP40	2 x 2,5	

* special versions S6, S8, S25 see on pages 191 - 194

SWITCHING PROGRAMS

SWITCH DISCONNECTOR WITH "0" (0-1) POSITION

Table 146.

Switching program	Diagram number
1-pole	90
2-pole	91
3-pole	10
multi-pole	92
	99
	100
	528
	659

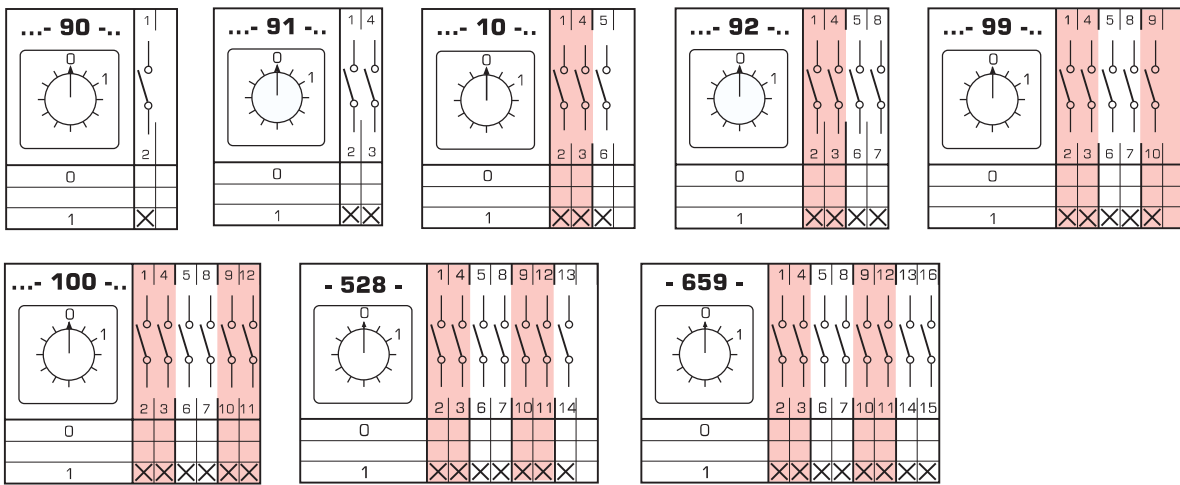

SWITCH DISCONNECTORS WITH QUICK-CONNECTING CONTACTS (0-1)

Table 147.

Switching program	Diagram number
with 30° contact lead 30°	1-pole 270
with 30° contact lead 30°	2-pole 271
with 30° contact lead 30°	3-pole 63
with 30° contact lead on three contacts and 60° on one contact	4-pole 272
with 30° contact lead on three contacts and 60° on two contacts	5-pole 273
with 30° contact lead 30°	6-pole 274

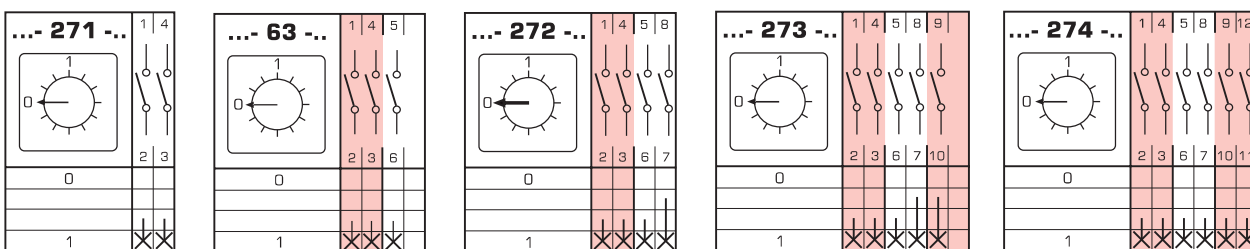
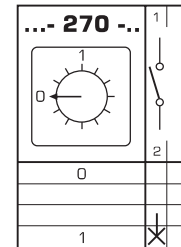

* see dimensions on pages 191 - 194

SWITCHES WITH "0"(1-0-2) POSITION

SWITCHES FOR CURRENT TRANSFORMERS (1-2)

Table 148.

Switching program	Diagram number
1-pole	51
2-pole	52
3-pole	53
multi-pole	75
	76
	77
	78
	79
	80
	81

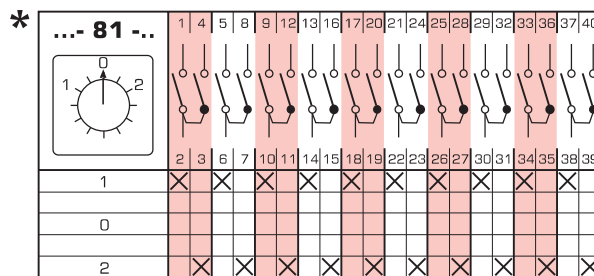
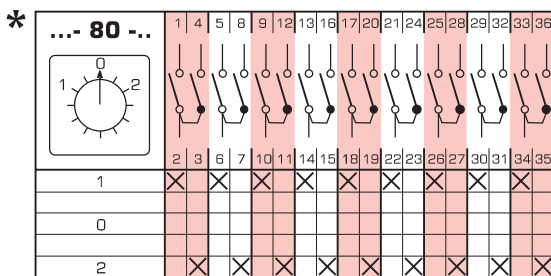
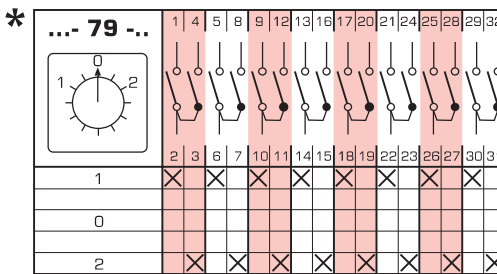
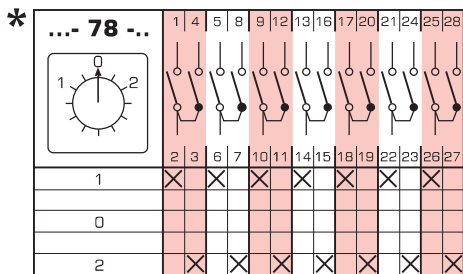
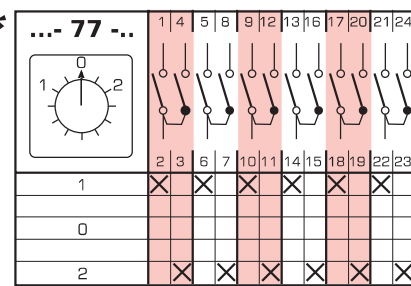
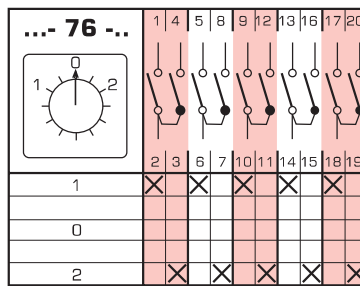
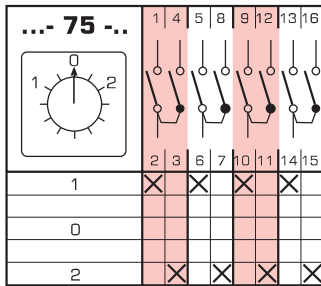
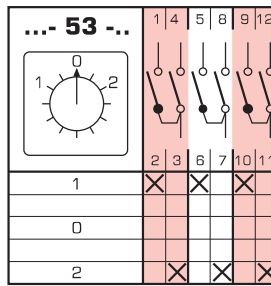
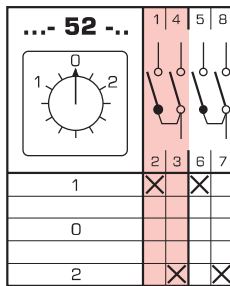
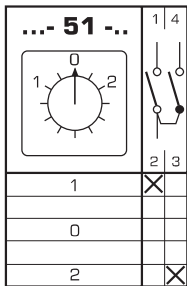
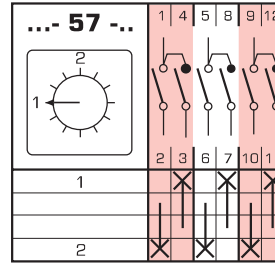

* only in versions U, O/U

* see dimensions on pages 191 - 194

SWITCHES WITHOUT "0"(1-2) POSITION

Table 149.

Switching program	Diagram number
1-pole	54
2-pole	55
3-pole	56
multi-pole	69
	70
	71
	72
	73
	74
	62

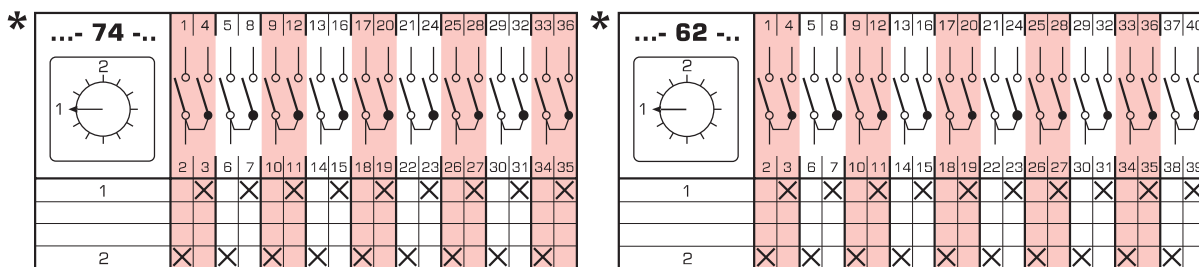
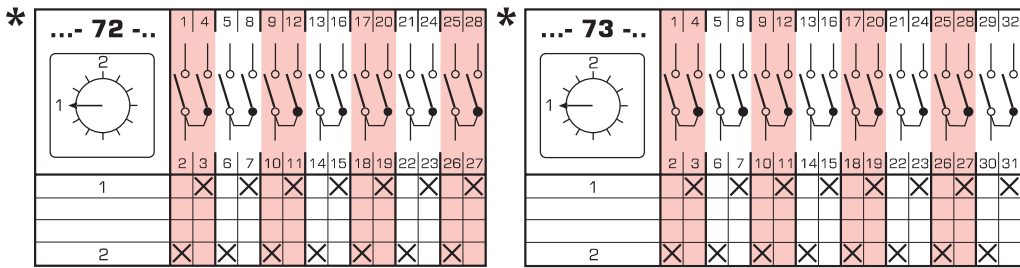
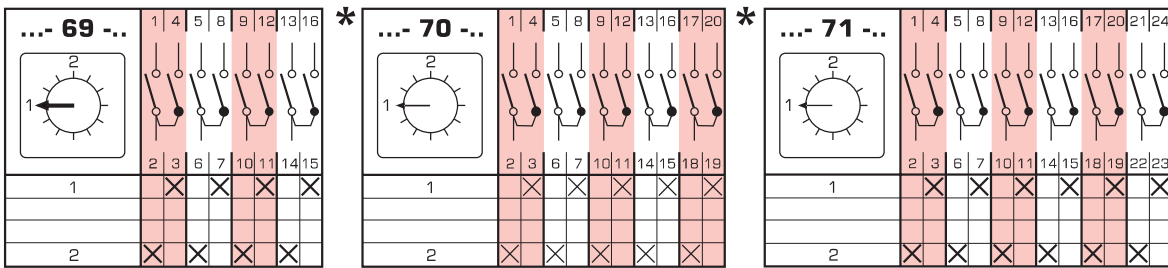
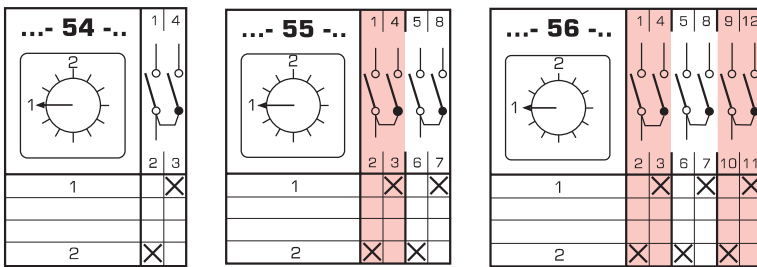

* only in versions U, OU

*see dimensions on pages 191 - 194



MULTIPOSITION SWITCHES WITH "0" (0-1-2...) POSITION

Table 150.

	Switching program	Diagram number	
1-pole	3-position	107	
	4-position	108	
	5-position	109	
	6-position	110	
	7-position	111	
	8-position	112	
	9-position	113	
	10-position	114	
	11-position	115	
	12-position	116	
	2-pole	3-position	123
		4-position	124
5-position		125	
6-position		126	
7-position		127	
8-position		128	
9-position		129	
10-position		130	
11-position		131	
12-position		132	
3-pole		3-position	135
		4-position	136
	5-position	137	
	6-position	138	
	7-position	139	
	8-position	140	
	multi-pole	3-position	145
4-position		146	
5-position		147	
6-position		148	
3-position		151	
4-position		152	
5-position		153	
3-position		156	
4-position		157	
5-position		158	
3-position		160	
4-position		161	
3-position		163	
4-position		164	

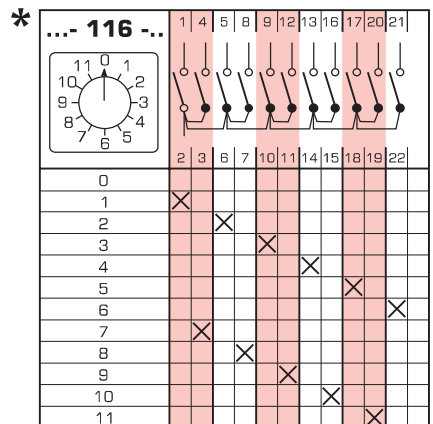
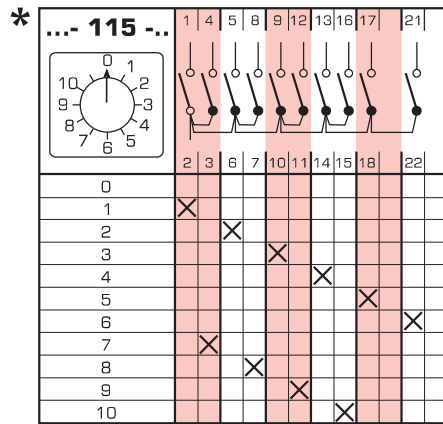
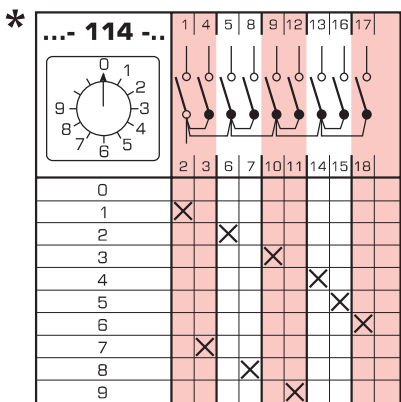
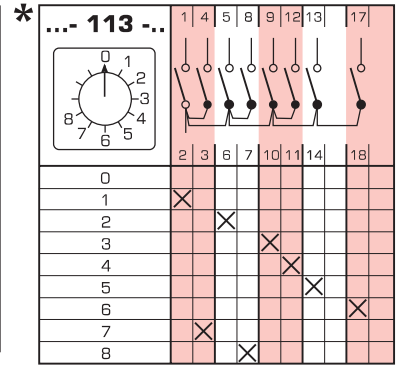
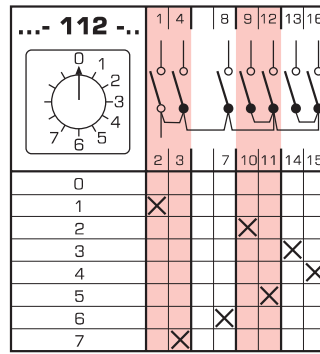
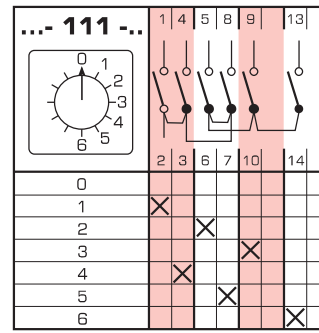
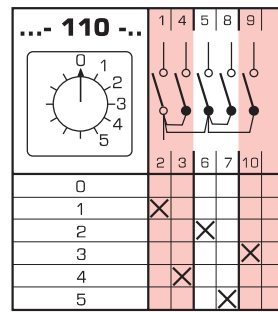
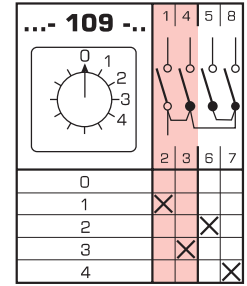
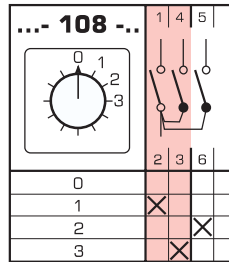
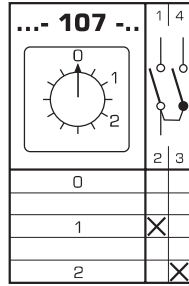

* only in versions U, O/U

* see dimensions on pages 191 - 194

MULTIPOSITION SWITCHES WITH "0" (0-1-2...) POSITION

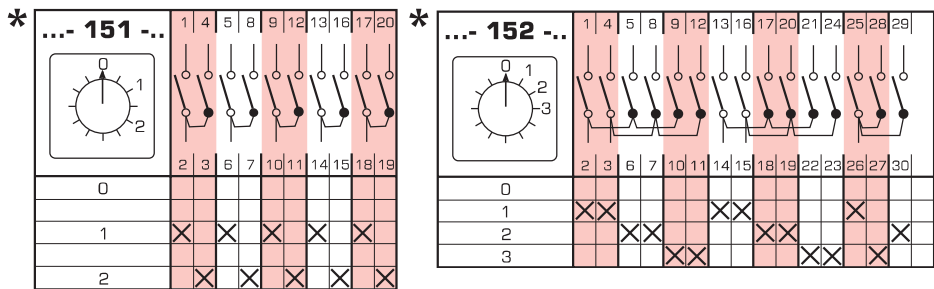
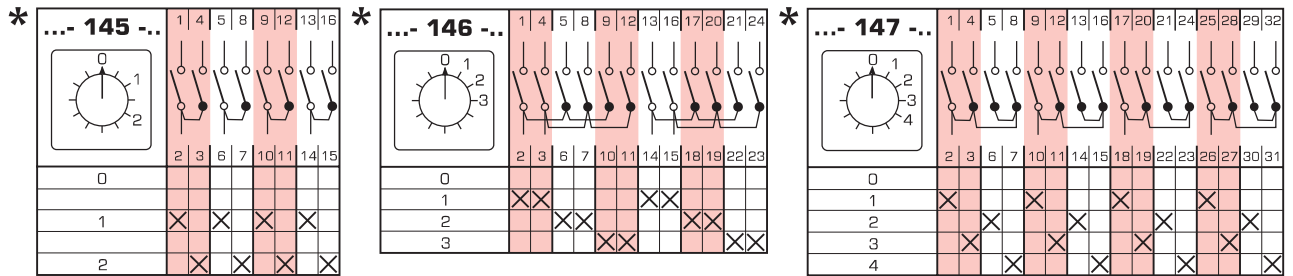
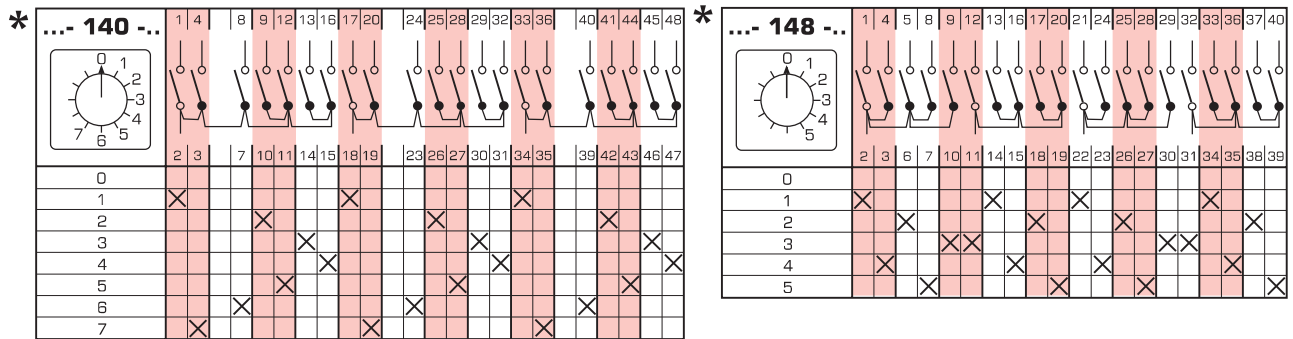
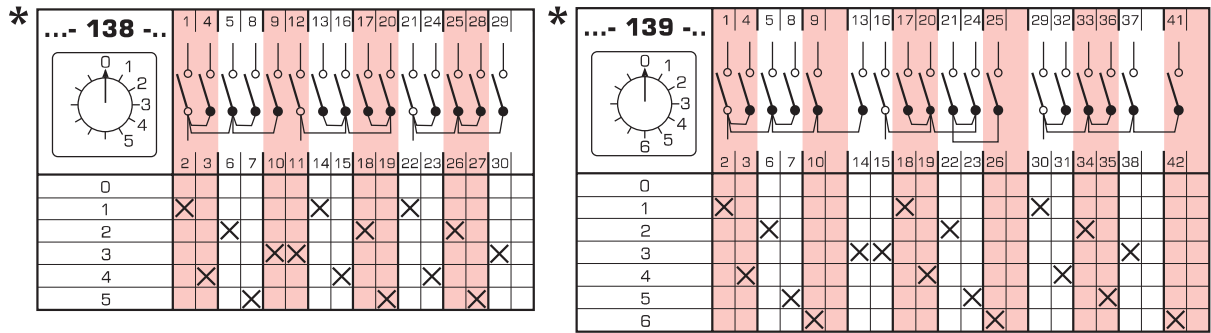
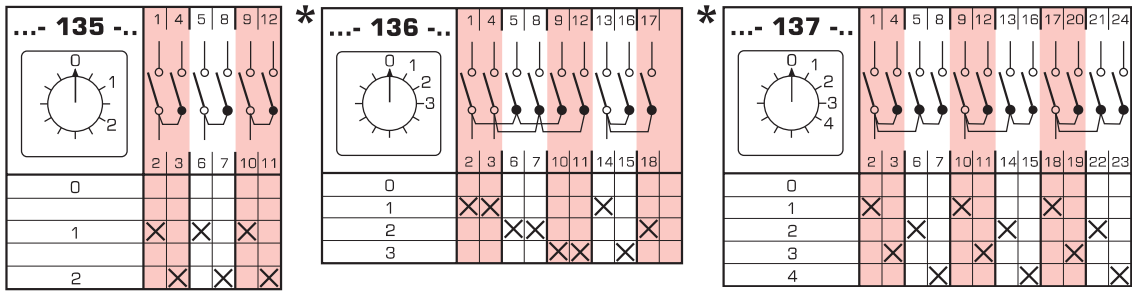

* only in versions U, O/U

* see dimensions on pages 191 - 194

MULTIPOSITION SWITCHES WITH "0" (0-1-2...) POSITION

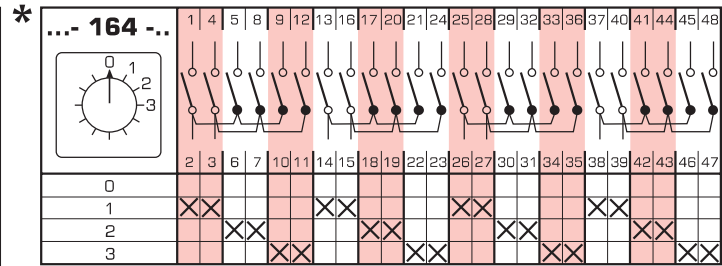
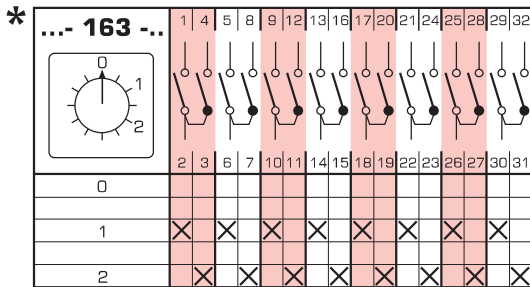
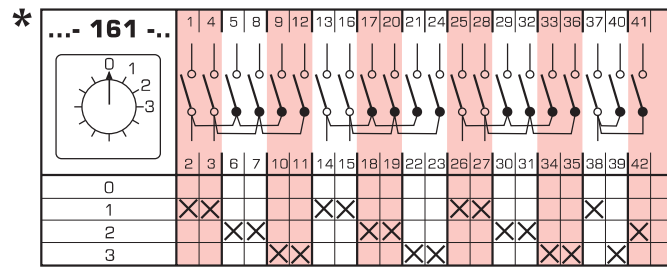
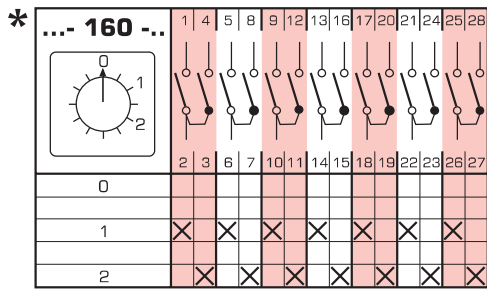
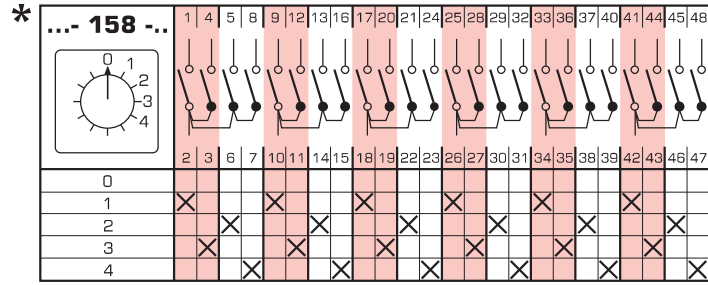
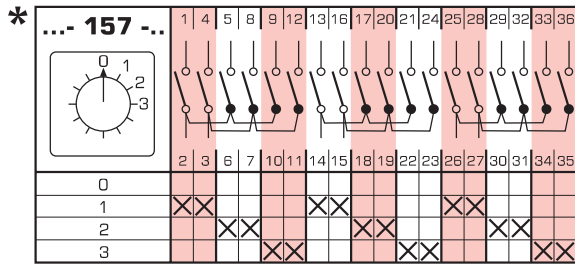
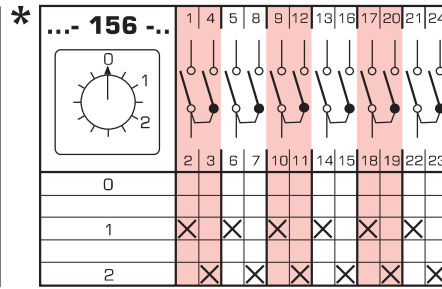
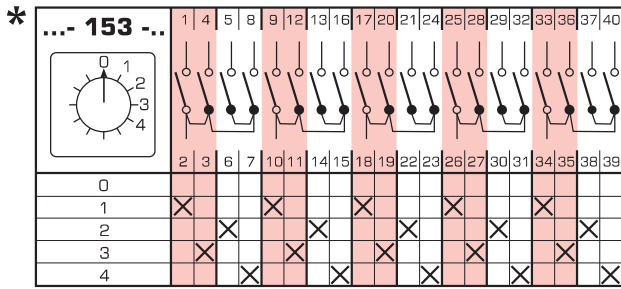

* only in versions U, OU

* see dimensions on pages 191 - 194

MULTIPOSITION SWITCHES WITHOUT "0" POSITION

Table 151.

Switching program		Diagram number	
1-pole	3-position	82	
	4-position	83	
	5-position	84	
	6-position	85	
	7-position	101	
	8-position	102	
	9-position	103	
	10-position	104	
	11-position	105	
	12-position	106	
	2-pole	3-position	86
		4-position	87
5-position		88	
6-position		89	
7-position		117	
8-position		118	
9-position		119	
3-pole	3-position	93	
	4-position	94	
	5-position	95	
	6-position	96	
	7-position	133	
	8-position	134	
multi-pole	3-position	141	
	4-position	142	
	5-position	143	
	6-position	144	
	3-position	149	
	4-position	150	
	3-position	154	
	3-position	155	
3-position	159		
3-position	162		

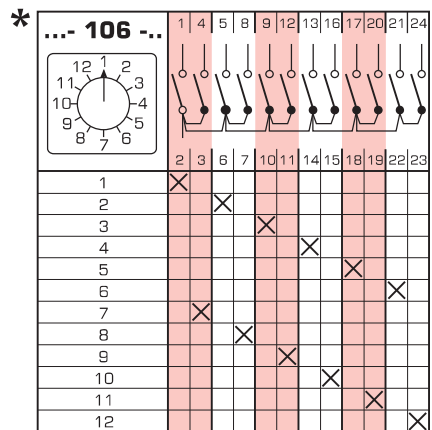
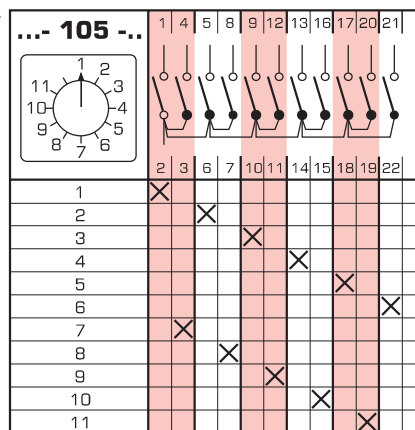
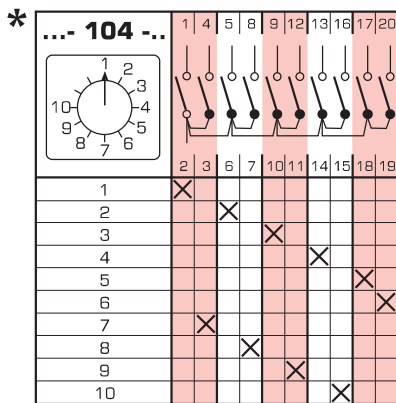
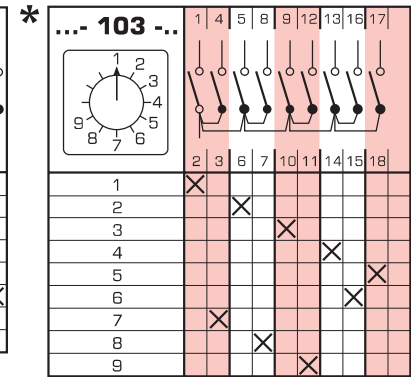
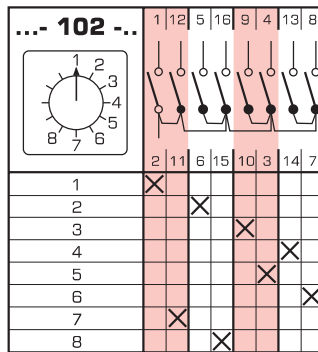
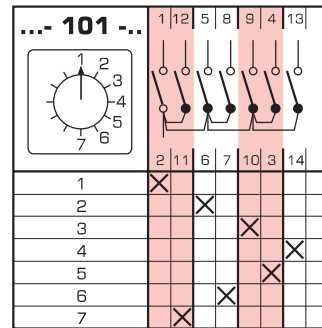
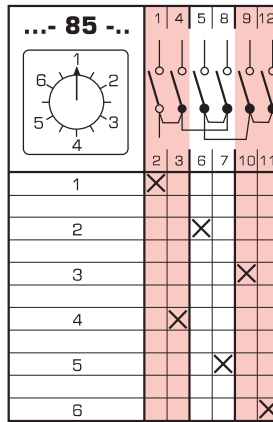
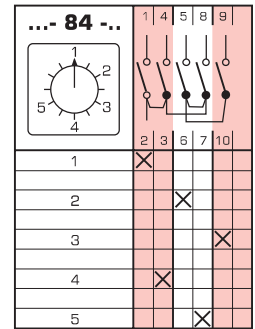
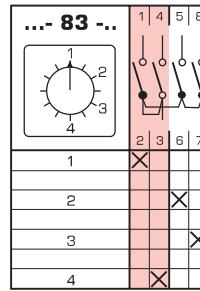
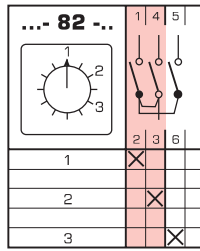

* only in versions U, O/U

* see dimensions on pages 191 - 194



MULTIPOSITION SWITCHES WITHOUT "0" POSITION

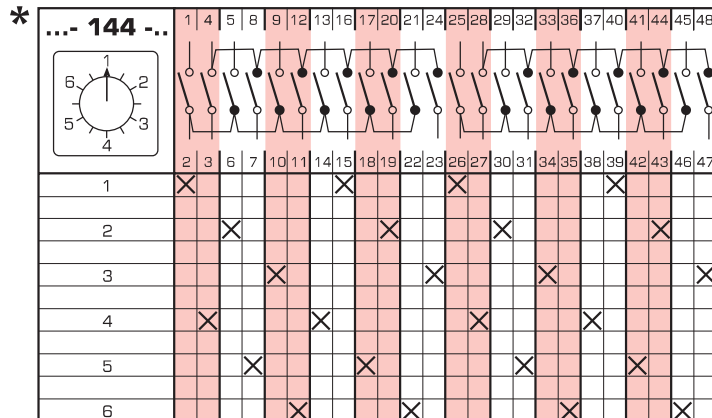
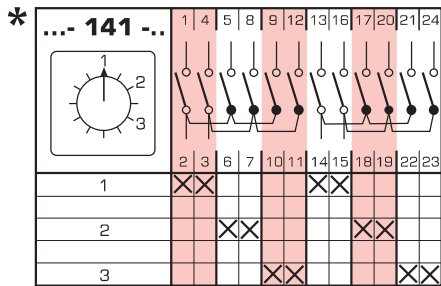
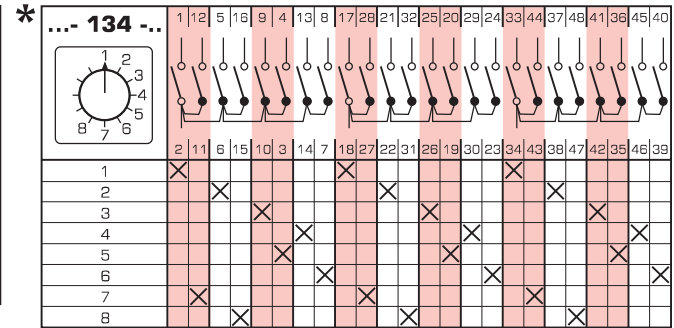
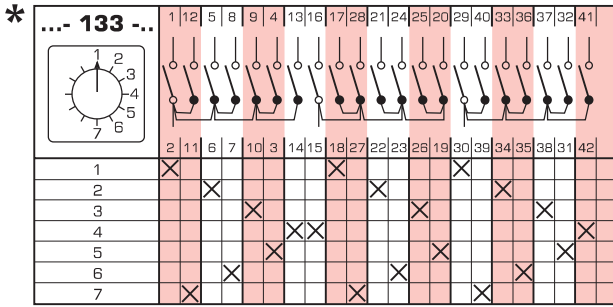
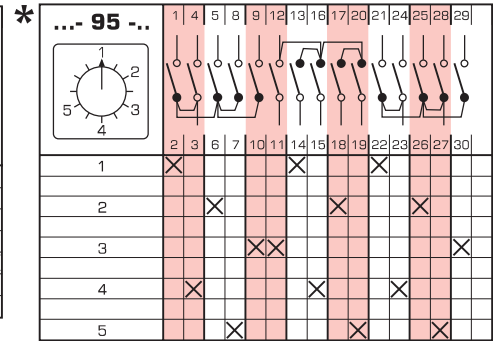
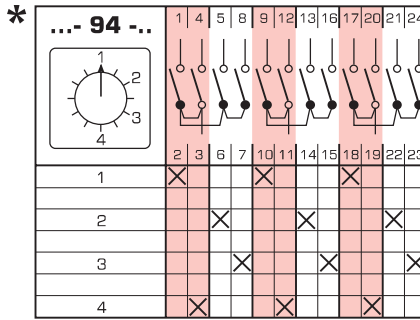
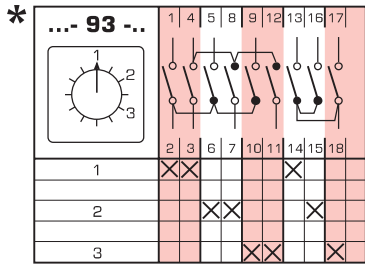
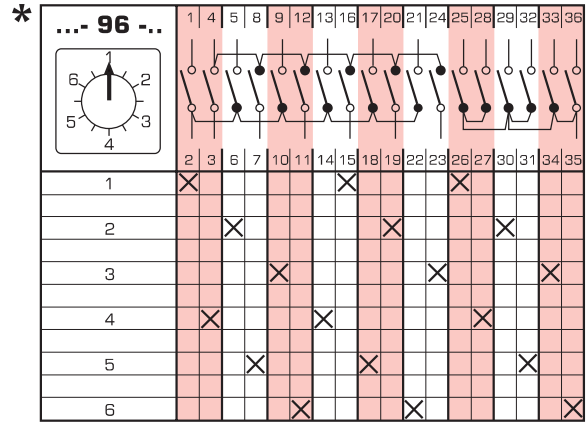
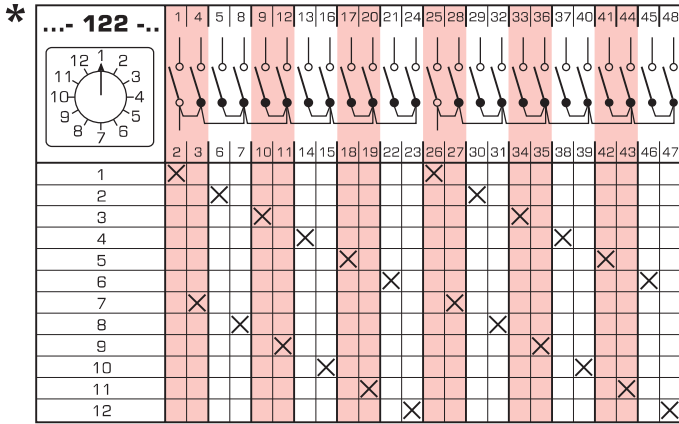

* only in versions U, OU

* see dimensions on pages 191 - 194

SWITCHGROUPS WITH "0" POSITION

Table 152.

Switching program		Diagram number
1-pole	2-group	251
	3-group	254
2-pole	2-group	252
	3-group	255
3-pole	2-group	253
	3-group	256

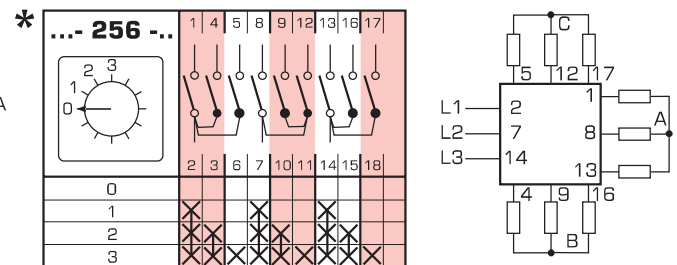
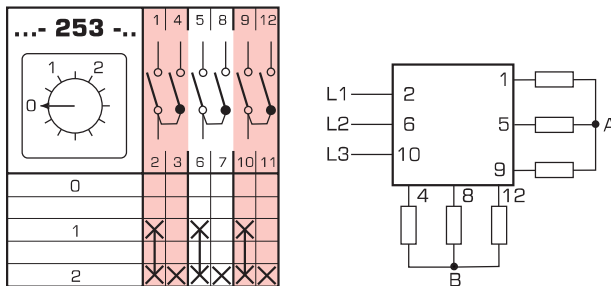
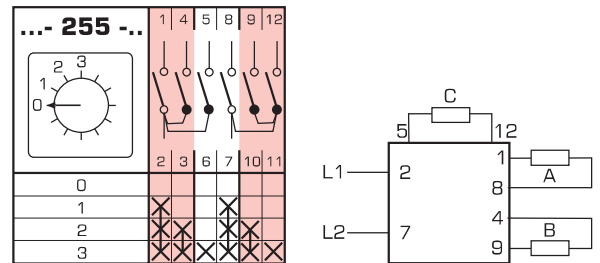
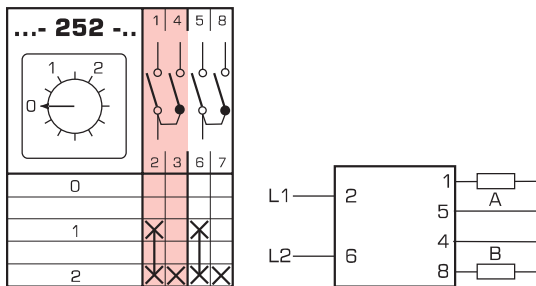
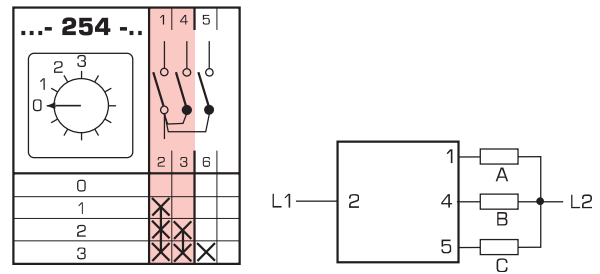
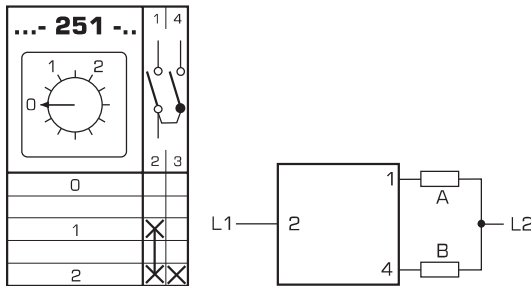

SERIAL SWITCHES

Table 153.

Switching program	Diagram number
1-pole	257
2-pole	258
3-pole	259

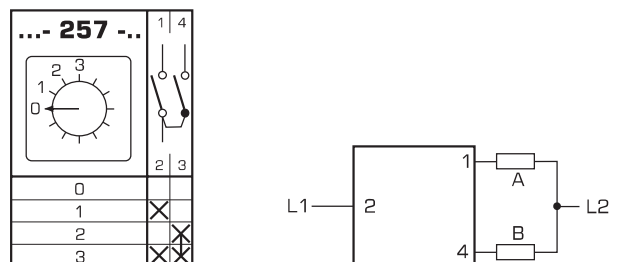

SERIAL SWITCHES

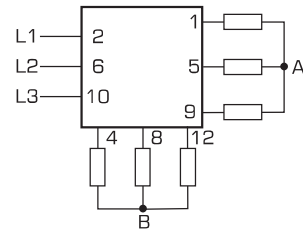
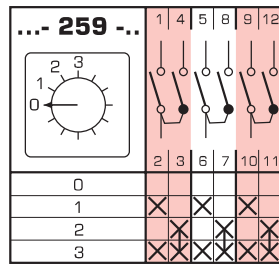
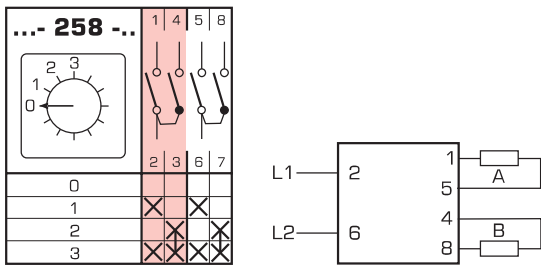

SERIAL-PARALLEL SWITCHES

Table 154.

Switching program	Diagram number
2-pole	260

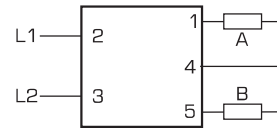
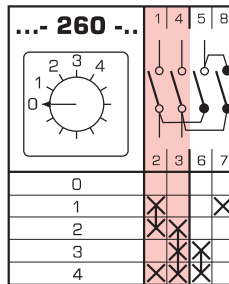

MEASUREMENT SWITCHES FOR VOLTAGE AND CURRENT

AMMETER SWITCHES

Table 155.

Switching program	Diagram number	
phase measurement	L1-L2-L3	58
phase measurement	0-1-2-3	97
phase measurement with grounding	0-1-2-3	98

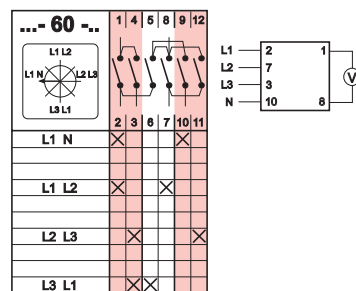
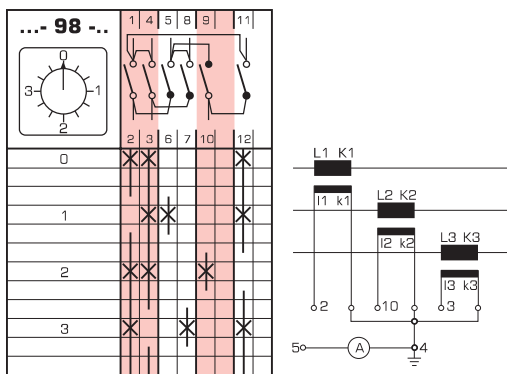
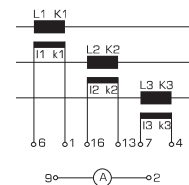
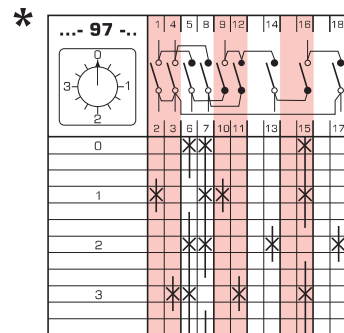
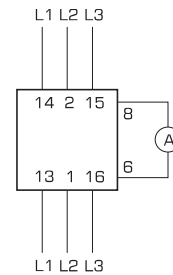
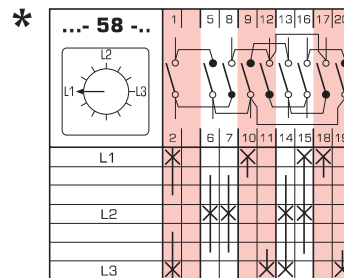

* only in versions U, QU

* see dimensions on pages 191 - 194

MEASUREMENT SWITCHES FOR VOLTAGE AND CURRENT

MEASUREMENT SWITCHES FOR VOLTAGE AND CURRENT, VOLTMETER SWITCHES WITHOUT "0" POSITION

Table 156.

Switching program	Diagram number
3 phase voltages	68
3 phase-to-phase voltages	67
3 phase-to-phase voltages + phase voltage	66

...- 66 -..

L3 L1	X	X	X	X
L2 L3	X	X	X	X
L1 L2	X	X	X	X
0				
L1 N	X	X	X	X
L2 N	X	X	X	X
L3 N	X	X	X	X

...- 67 -..

0				
L1 L2	X	X	X	X
L2 L3	X	X	X	X
L3 L1	X	X	X	X

...- 68 -..

0				
L1 N	X	X	X	X
L2 N	X	X	X	X
L3 N	X	X	X	X

SWITCHES WITH AUTOMATIC RETURN TO INITIAL POSITION

SWITCH WITH "0" POSITION (1-0-2), RETURN TO "0" FROM BOTH SIDES

Table 157.

Switching program	Diagram number
switches with automatic return to initial position, switch with function of left - right pushbuttons	210
switch with "0" position (1-0-2) return to "0" from both sides	
1-pole	201
2-pole	202
3-pole	203

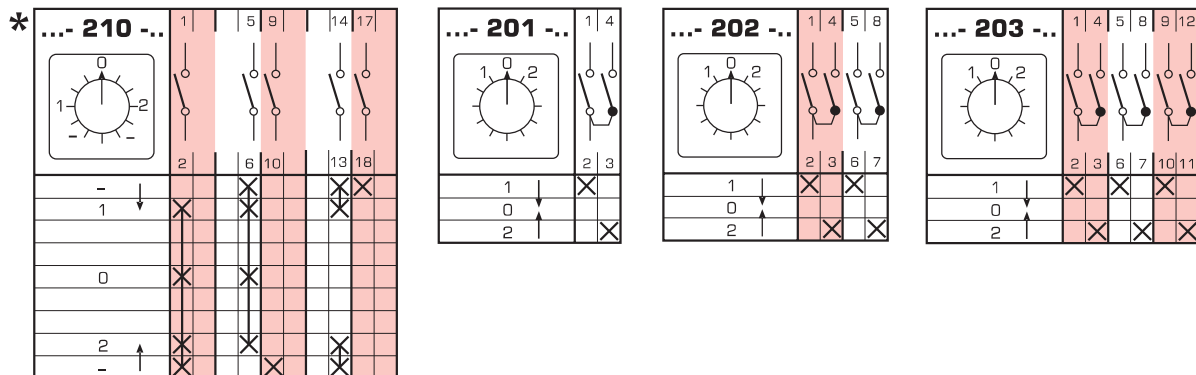

SWITCHES WITH AUTOMATIC RETURN TO INITIAL POSITION

SWITCHES WITHOUT "0" (0-2) POSITION

Table 158.

Switching program	Diagram number
1 normally closed contact + 1 normally open contact	204
2 normally closed contacts + 2 normally open contacts	205
3 normally closed contacts + 3 normally open contacts	206
to control a contactor – 1 normally open contact (turn right) and 1 normally closed contact (turn left)	207
1 normally open contact and 1 normally closed contact, when turning left and right	208
2 normally open contacts and 2 normally closed contacts, when turning left and right	209

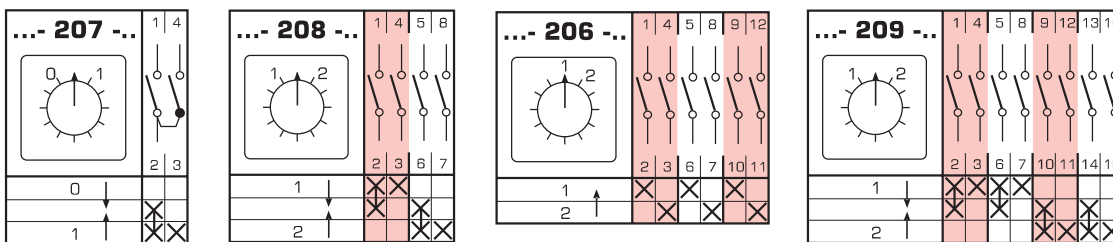
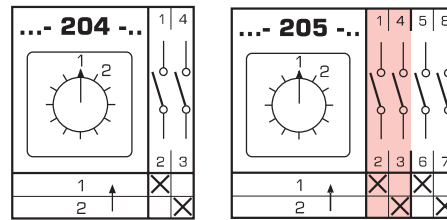

SWITCH DISCONNECTORS FOR MOTOR CONTROLLING

STAR-DELTA SWITCH DISCONNECTORS

Table 159.

Switching program	Diagram number
basic version	12
Y/Δ back from Y to 0	28
with counter-current braking back from Y to 0	29
as a voltage switch	30
for operation with contactor	31
bidirectional (left-right)	21

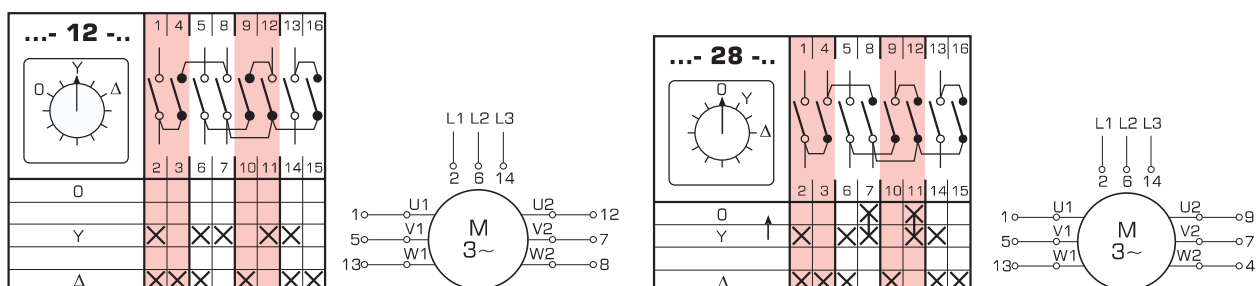

* see dimensions on pages 191 - 194

STAR-DELTA SWITCH DISCONNECTORS

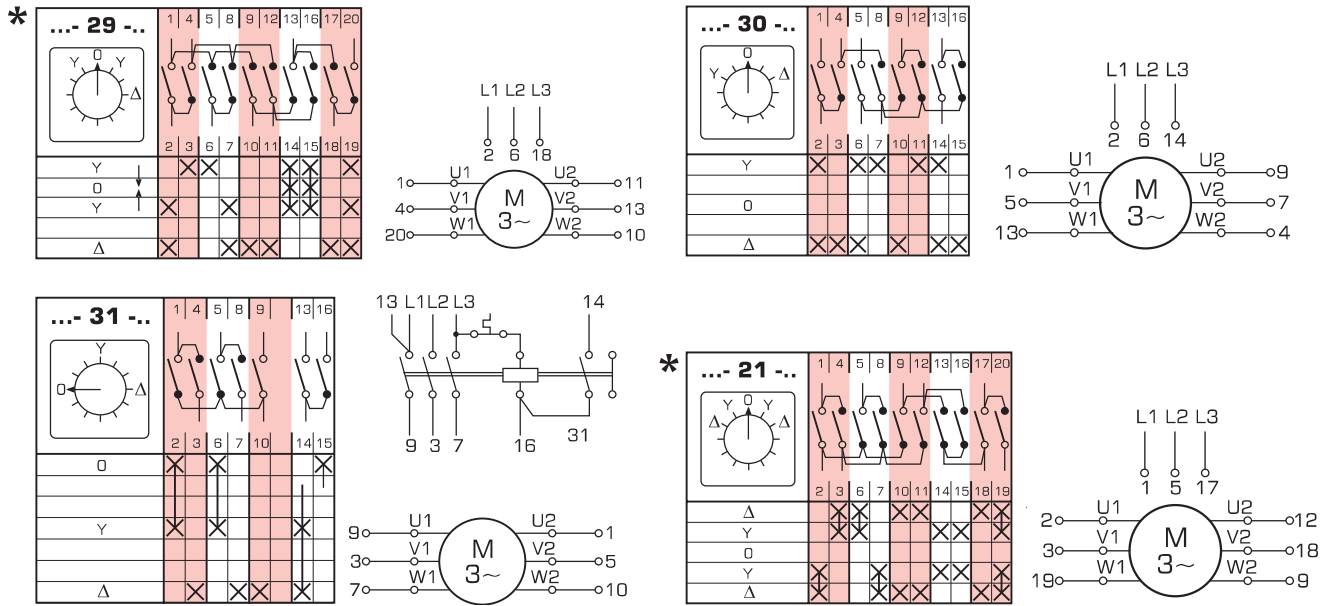

* only in versions U, OU

SWITCH DISCONNECTORS IN A DAHLANDER'S SYSTEM

Table 160.

Switching program	Diagram number
Switch disconnectors for motor controlling, switch disconnectors in a dahlander's system dipolar Δ -0-YY	13
Dipolar 0- Δ -YY	19
Dipolar bidirectional YY- Δ -0- Δ -YY	20
Dipolar and contactor controlling	32

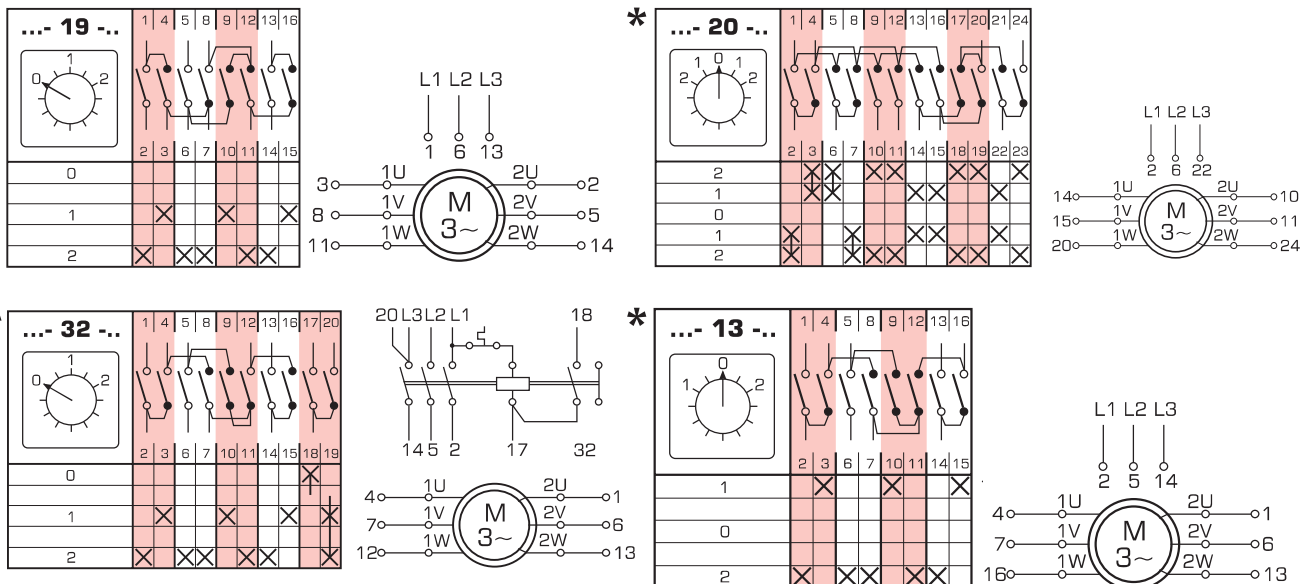

* only in versions U, OU

* see dimensions on pages 191 - 194

SWITCH DISCONNECTORS FOR MOTOR CONTROLLING

SWITCH DISCONNECTORS FOR TWO-WINDING MOTORS

Table 161.

Switching program	Diagram number
0-1-2	22
bidirectional	23
to control the contactors	33

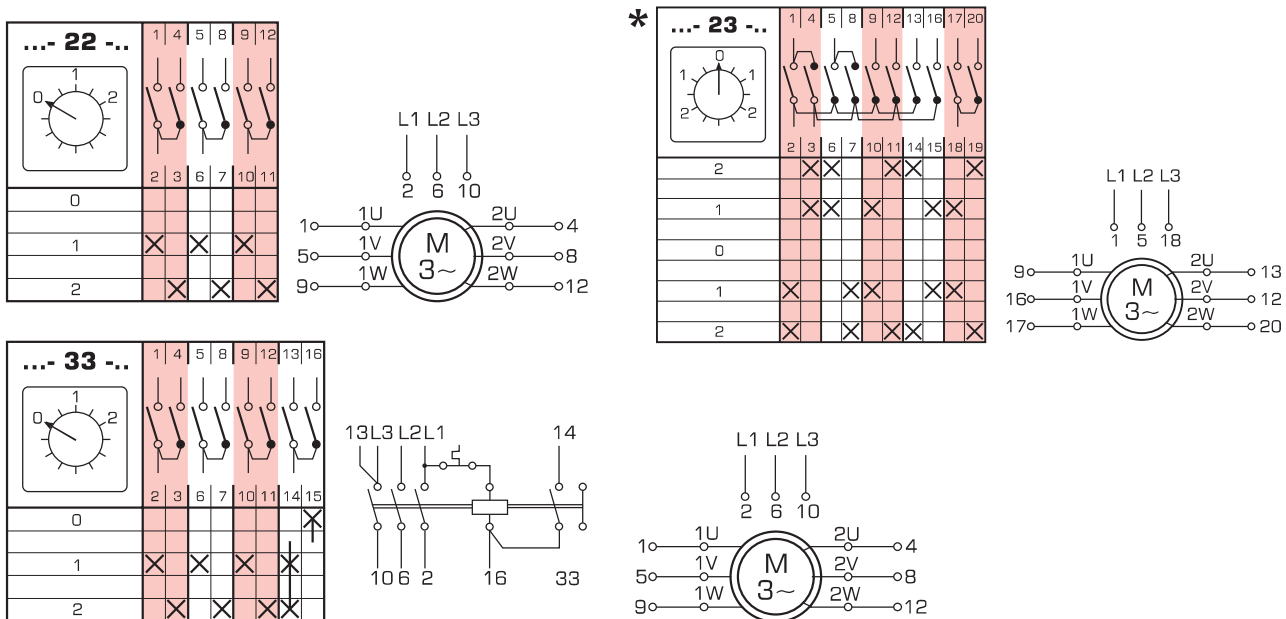

* only in versions U, OU

* see dimensions on pages 167-170

SWITCH DISCONNECTORS FOR THREE-SPEED MOTORS

Table 162.

Switching program	Diagram number
2 windings 0-Δ-Y-YY (with 3 speeds in a Dahlander's system)	34
2 windings 0-Δ-YY-Y (1 and 2 speeds in a Dahlander's system)	35
2 windings 0-Y-Δ-YY (2 and 3 speeds in a Dahlander's system)	36

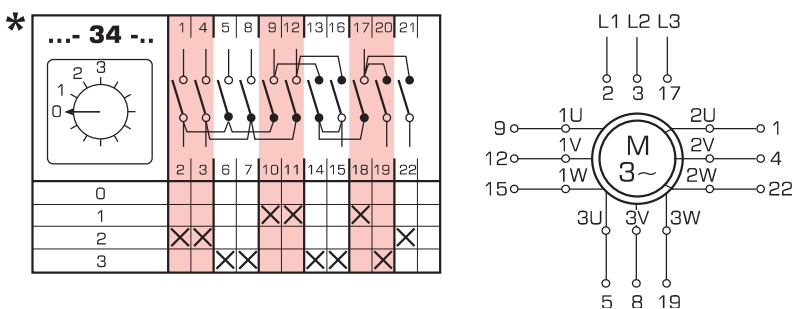

* only in versions U, OU

* see dimensions on pages 191 - 194

SWITCH DISCONNECTORS FOR THREE-SPEED MOTORS

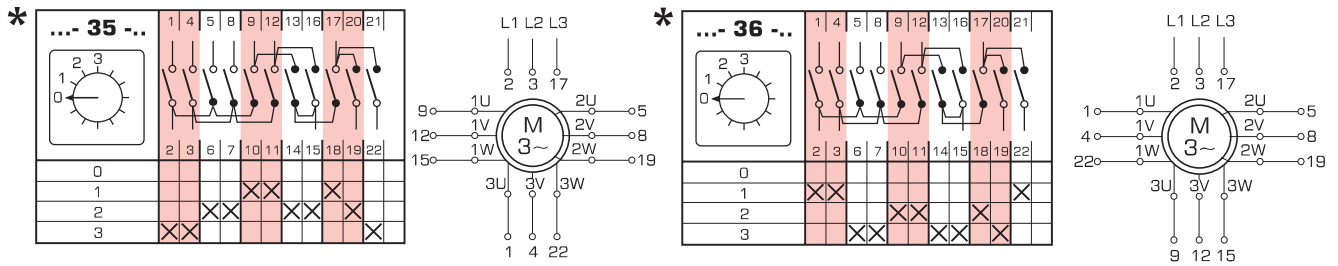

* only in versions U, OU

SWITCH DISCONNECTORS FOR MOTOR CONTROLLING

REVERSING SWITCHES

Table 163.

Switching program	Diagram number
2-pole	24
2-pole, return to "0" position	25
3-pole	11
3-pole, return to "0" position	26
to control a contactor	27
starting switches for 1-phase motors	15

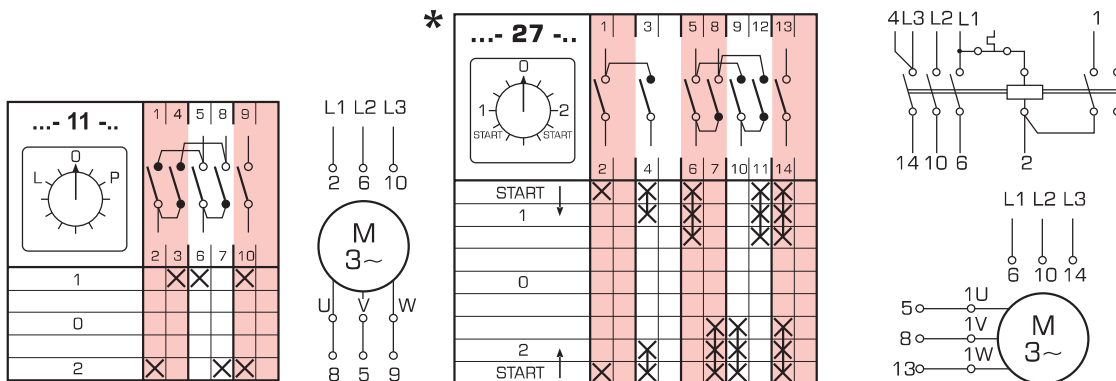
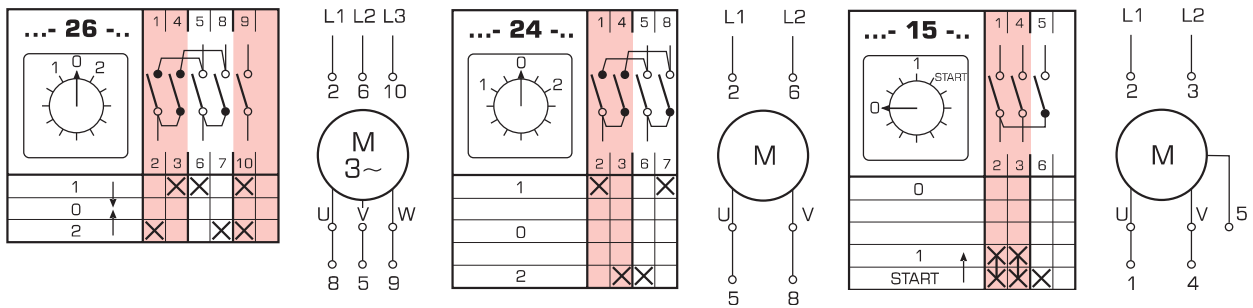
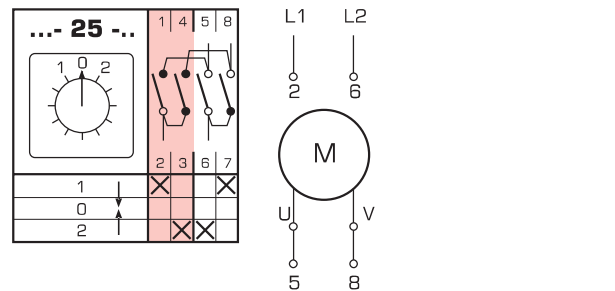

OVERALL DIMENSIONS

STANDARD VERSION FRONT PLATE

group	B	E
	∅	
A0	48	7,5
A1	65	9,5
A2	90	9,5
A3	132	10

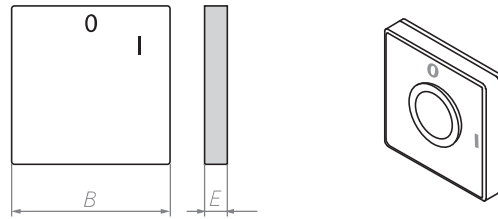

group	D	P	R	B	F
	∅				
A0	27,5	19	23,5	39,5	16
A1	35	25	32	53	20
A2	48	32	43,5	70,5	26
A3	75	46,5	63,5	104	39

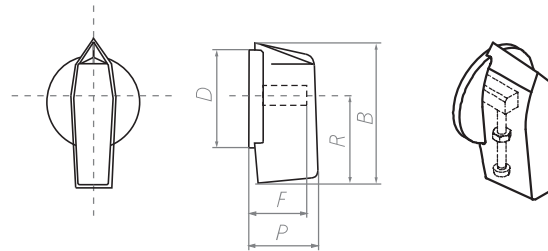

group	D	P	R	B	F
	∅				
A1	35	51	61,5	81,5	15
A2	48	64	79,5	105,5	19
A3	75	88	115	155,5	28

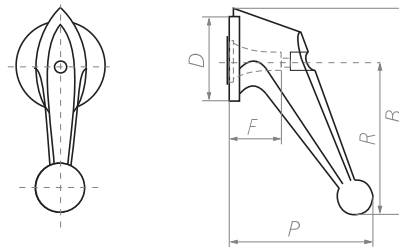

SWITCHES INSTALLED UNDER THE PANEL

group	D1	D2	A
	∅	∅	∅
A0	5	14	36
A1	5	14	48
A2	6	16	72
A3	6	18	104

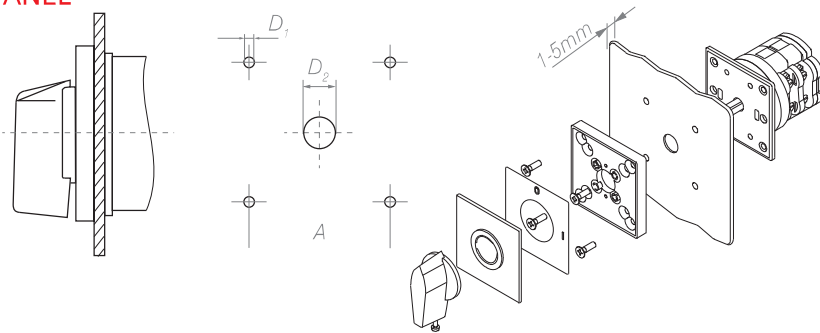

SWITCHES INSTALLED ON THE PANEL

group	D1	D2	A
	∅	∅	∅
A0	5	42,5	36
A1	5	59	48
A2	6	82	72

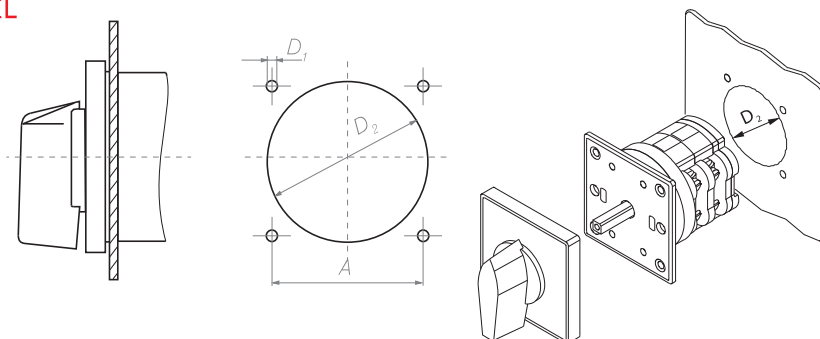

OVERALL DIMENSIONS

U SWITCHES TO BE BUILT-IN

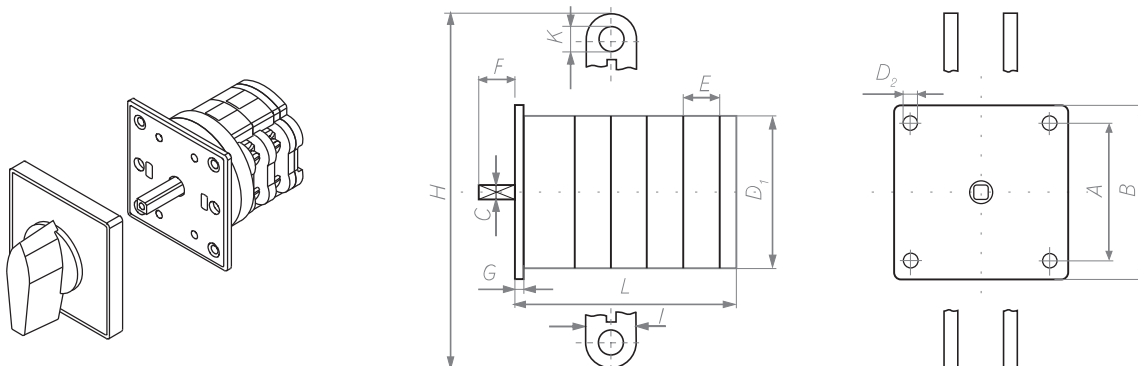

group	switch type	D ₁	D ₂	A	B	C	E	F	G	H	I	K
		∅	∅	∅	∅	∅						
A0	4G 10	38	4,3	36	48	6	9,6	22	4	–	–	–
A1	4G 16	57	4,3	48	65	6	13,5	26	3	–	–	–
	4G 25	57	4,3	48	65	6	13,5	26	3	–	–	–
A2	4G 40	80	5,3	72	90	8	18	31	5	–	–	–
	4G 63, 80	80	5,3	72	90	8	18	31	5	–	–	–
A3	4G 100	120	5,3	104	132	10	29	37,5	6	–	–	–
	4G 200	120	5,3	104	132	10	29	37,5	6	145	20	10,5
	4G 400	120	5,3	104	132	10	29	37,5	6	170	45	13
	4G 630	120	5,3	104	132	10	29	37,5	6	190	74	17,5
	4G 800	120	5,3	104	132	10	29	37,5	6	260	50	17,5
	4G 1200	120	5,3	104	132	10	29	37,5	6	260	80	17,5

group	switch type	L (depending on the number of switching elements)											
		1	2	3	4	5	6	7	8	9	10	11	12
A0	4G 10	33	42,5	52	61,5	71	81	90,5	100	109,5	119	129	138,5
A1	4G 16	46,5	60	73,5	87,5	101	114,5	128,5	143	156	169,5	183	196,5
	4G 25	46,5	60	73,5	87,5	101	114,5	128,5	143	156	169,5	183	196,5
A2	4G 40	56,5	74,5	92,5	110,5	128,5	146,5	164,5	182,5	200,5	218,5	236,5	254,5
	4G 63, 80	56,5	74,5	92,5	110,5	128,5	146,5	164,5	182,5	200,5	218,5	236,5	254,5
A3	4G 100	77	107	136	166	196	226	284	314	343	373	402	432
	4G 200	77	107	136	166	196	226	284	314	343	373	402	432
	4G 400	–	107	–	166	–	226	–	314	–	373	–	432
	4G 630	–	–	136	–	–	226	–	–	343	–	–	432
	4G 800	–	107	–	166	–	226	–	314	–	373	–	432
	4G 1200	–	–	136	–	–	226	–	–	343	–	–	432

protection degree IP40 (from the front plate side), IP55 in a special version – S1

OVERALL DIMENSIONS

OU SWITCHES TO BE BUILT IN A HOUSING

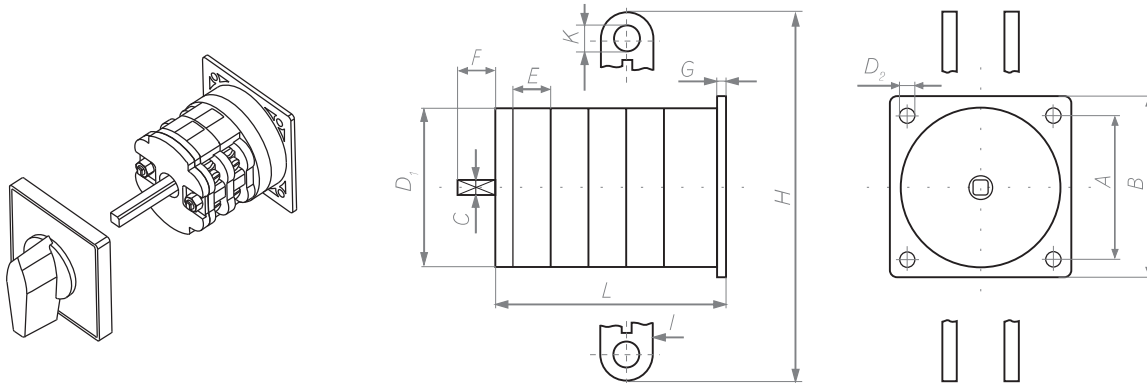

group	switch type	D ₁	D ₂	A	B	C	E	F	G	H	I	K
		∅	∅	Φ	Φ	Φ						
A0	4G 10	38	4,3	36	48	6	9,6	32	4	–	–	–
A1	4G 16	57	4,3	48	65	6	13,5	35	3	–	–	–
	4G 25	57	4,3	48	65	6	13,5	35	3	–	–	–
A2	4G 40	80	5,3	72	90	8	18	40	5	–	–	–
	4G 63, 80	80	5,3	72	90	8	18	40	5	–	–	–
A3	4G 100	120	5,3	104	132	10	29	50	6	–	–	–
	4G 200	120	5,3	104	132	10	29	50	6	145	20	10,5
	4G 400	120	5,3	104	132	10	29	50	6	170	45	13
	4G 630	120	5,3	104	132	10	29	50	6	190	74	17,5
	4G 800	120	5,3	104	132	10	29	50	6	260	50	17,5
	4G 1200	120	5,3	104	132	10	29	50	6	260	80	17,5

group	switch type	L (depending on the number of switching elements)											
		1	2	3	4	5	6	7	8	9	10	11	12
A0	4G 10	33	46,5	56	65,5	75	85	94,5	104	113,5	123	133	142,5
A1	4G 16	46,5	60	73,5	87,5	101	114,5	128,5	143	156	169,5	183	196,5
	4G 25	46,5	60	73,5	87,5	101	114,5	128,5	143	156	169,5	183	196,5
A2	4G 40	56,5	74,5	92,5	110,5	128,5	146,5	164,5	182,5	200,5	218,5	236,5	254,5
	4G 63, 80	56,5	74,5	92,5	110,5	128,5	146,5	164,5	182,5	200,5	218,5	236,5	254,5
A3	4G 100	77	107	136	166	196	226	284	314	343	373	402	432
	4G 200	77	107	136	166	196	226	284	314	343	373	402	432
	4G 400	–	107	–	166	–	226	–	314	–	373	–	432
	4G 630	–	–	136	–	–	226	–	–	343	–	–	432
	4G 800	–	107	–	166	–	226	–	314	–	373	–	432
	4G 1200	–	–	136	–	–	226	–	–	343	–	–	432

protection degree IP40 (from the front plate side), IP55 in a special version – S1



INSTALLATION DIMENSIONS

PK SWITCHES IN A PLASTIC HOUSING - PROTECTION DEGREE IP 55

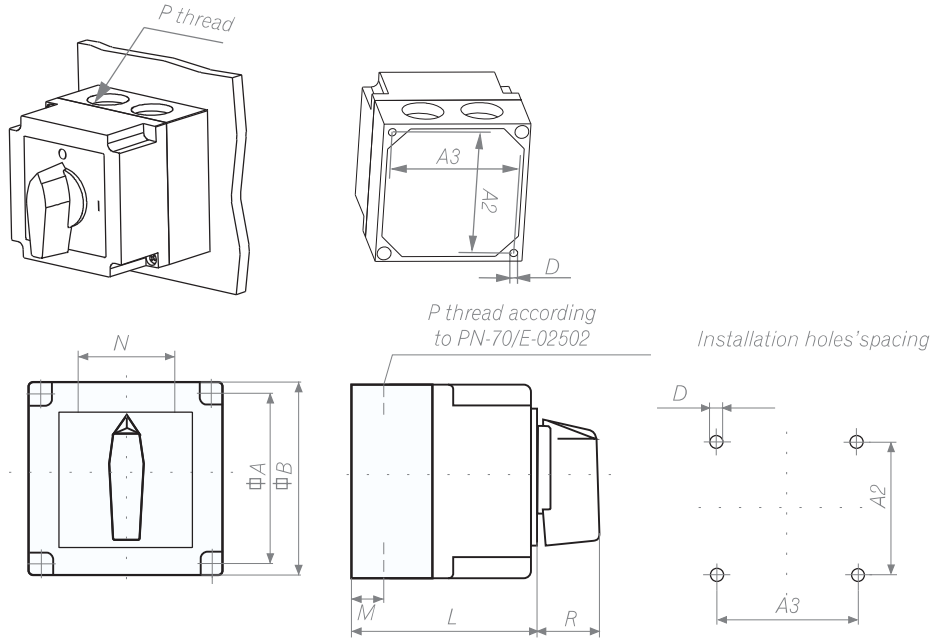

group	Switch type	D	A1	A2	A3	B	M	N	R	Thread P	L (depending on the number of the switching elements)			
		∅	Φ			Φ					1	2	3	4
A0	4G 10	4,3	55	38	54	64	13	25	19	11	55,5	55,5	75	75
A1	4G 16	4,3	75	75	75	85	19	34	25	16	77	77	104	104
	4G 25	4,3	75	75	75	85	19	34	25	16	77	77	104	104
A2	4G 40	5,3	109	91	107	120	29	45	32	21	95	95	132	132
	4G 63, 4G 80	5,3	109	91	107	120	29	45	32	21	95	95	132	132

PK CAM SWITCHES IN THERMOPLASTIC ENCLOSURES WITH IP 65 DEGREE OF PROTECTION

Installation holes spacing

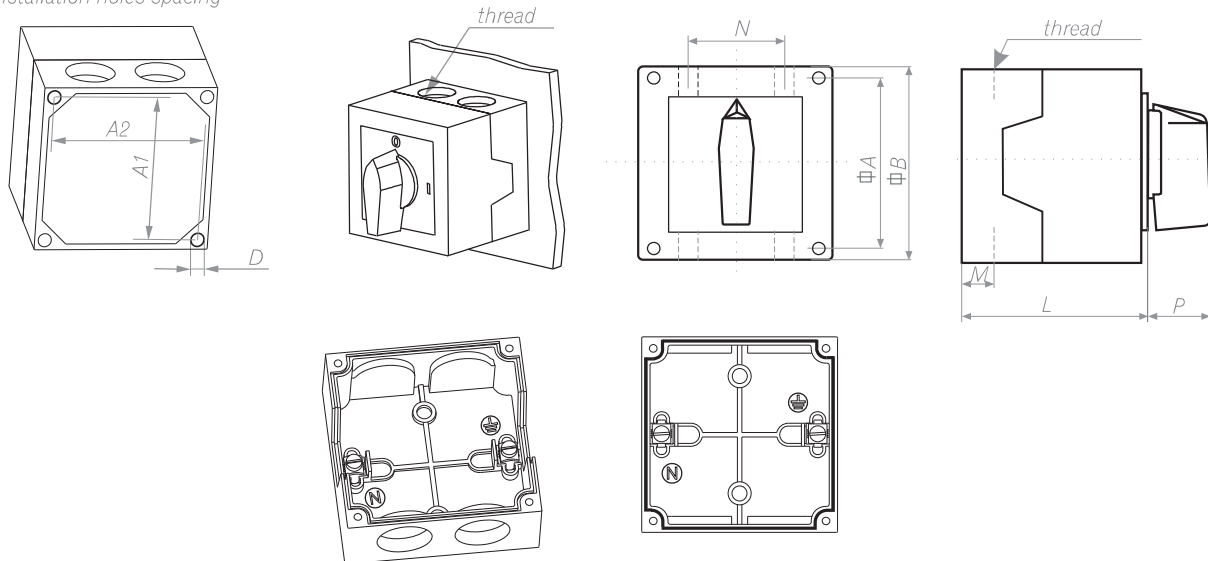

group	Switch type	D	A	B	A1	A2	M	N	P	Thread	L (depending on the number of the switching elements)	
		∅	Φ	Φ							1 or 2	3 or 4
A0	4G 10	4,5	64	75	50	64	14	28	19	M20	60	81,5

SPECIAL VERSIONS

S1 SWITCH WITH A SEALED SHAFT /PROTECTION CLASS IP 55/

group A0, A1, A2 version U, OU

The difference between standard and special versions is the use of a sealing ring on the driving shaft, which guarantees achieving an IP 55 housing tightness.

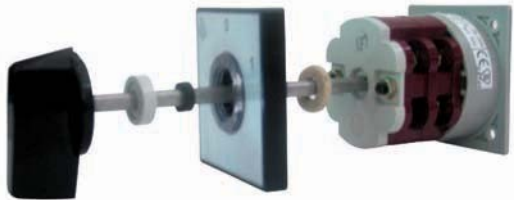

S5 SWITCH WITH A CYLINDRICAL LOCK

group A1, A2 version U

Blocking when ordered.

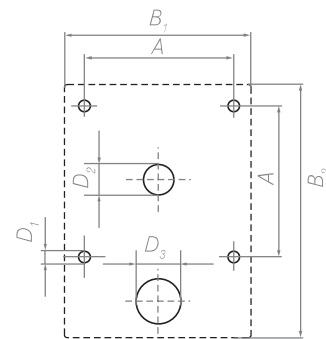
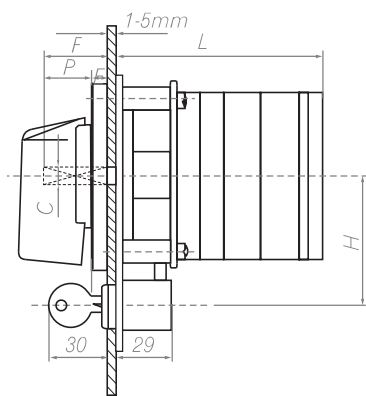

Group	D ₁	D ₂	D ₃	A	B ₁	B ₂	C	E	F	H	P	
								Φ				
A1	5	14	21,5	48	65	98	6	9,5	26	48	25	
A2	6	16	21,5	72	90	122	8	9,5	31	60	32	

Group	L (depending on the number of the switching elements)											
	1	2	3	4	5	6	7	8	9	10	11	12
A1	72,5	86	99,5	113,5	127	140,5	154,5	169	182	195,5	209	222,5
A2	82,5	100,5	118,5	136,5	154,5	172,5	190,5	208,5	226,5	244,5	262,5	280,5

**S6 SWITCH WITH PADLOCK BLOCKING**

group A0, A1, A2 version U. PK
Blocking only in 0 position

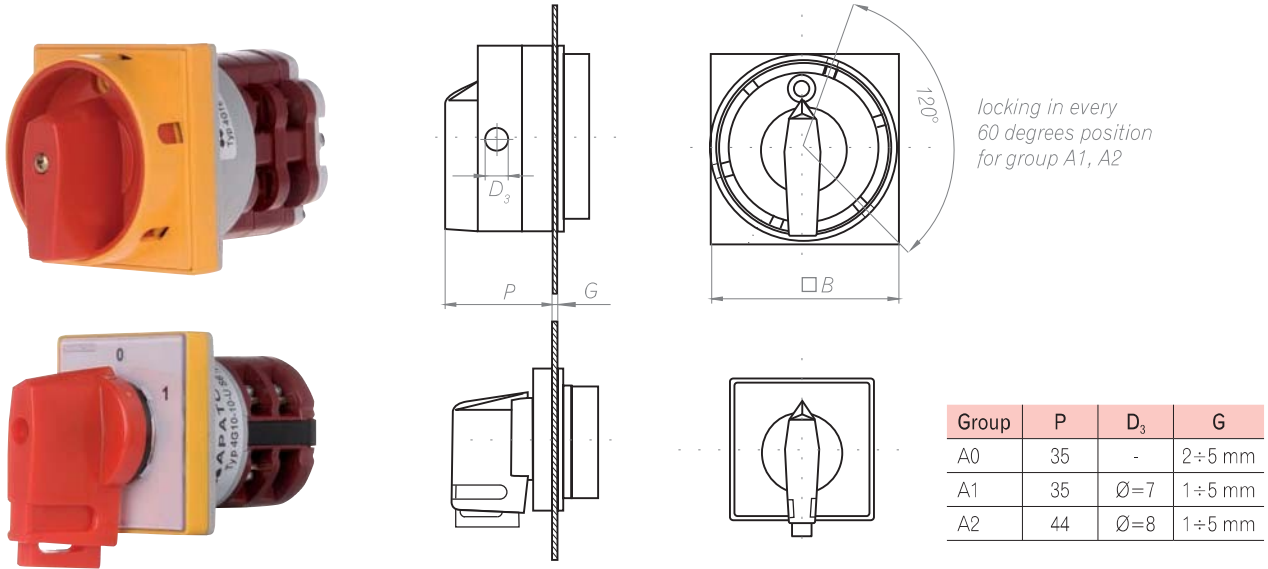
**S7 SWITCH WITH A DOOR COUPLING**

group A1, A2 version OU

The switch for installation on the back wall of the housing /cubicle/. The knob with a front plate is placed on the cover or on the door. The shaft may be lengthened and sealed.

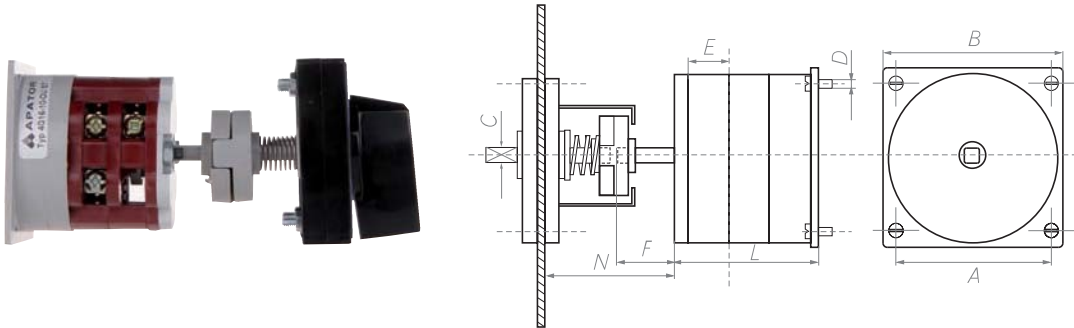
**S8 SWITCH WITH A DOOR COUPLING AND A DOOR BLOCKING**

group A1, A2 version OU

The features are like for S7, but the door can be opened in a zero position, for example.

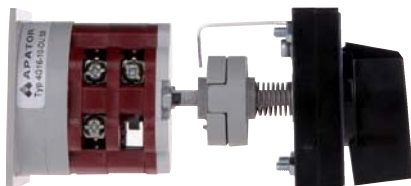

Group	D	A	B	C	E	F	N*	L (depending on the number of the switching elements)											
	∅	∅	∅	∅				1	2	3	4	5	6	7	8	9	10	11	12
A0	4	48	65	6	13,5	16,5	54	46,5	60	73,5	87,5	101	114,5	128,5	143	156	169,5	183	196,5
A1	5	72	90	8	18	17	60	56,5	74,5	95,5	110,5	128,5	146,5	164,5	182,5	200,5	218,5	236,5	254,5

S9 SWITCH FOR INSTALLATION IN $\varnothing 30,5$ (IN CONTROL BOARDS WITH STANDARD HOLES)

group A0 version U

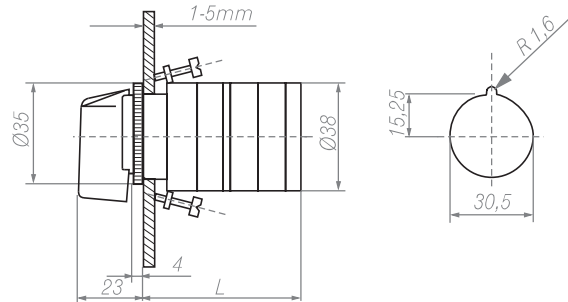
**S10 SWITCH FOR INSTALLATION IN A $\varnothing 30,5$ HOLE**

group A0 version U

(Like for S9), the key operates as a knob. Closing in positions 3, 6, 9, 12 /like on a clock/. The key can be removed in the same positions.

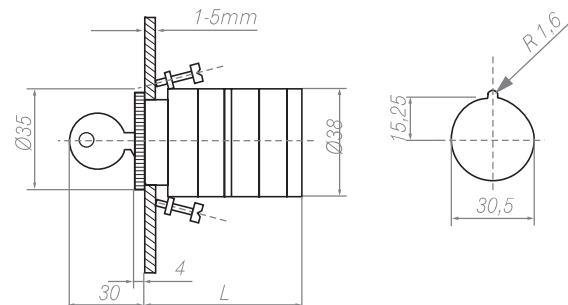
**S11 SWITCH FOR INSTALLATION IN A $\varnothing 22,5$ HOLE (CONTROL BOARDS)**

group A0 version U

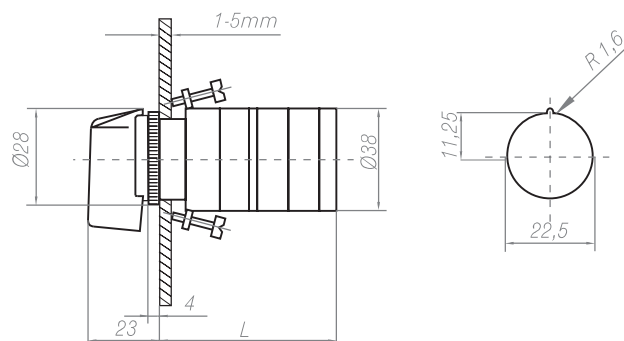



S12 SWITCH FOR INSTALLATION IN A Ø22,5 HOLE (LIKE FOR S11)

group A0 version U

The key operates as a knob. Closing and removing the key in positions like for S10.

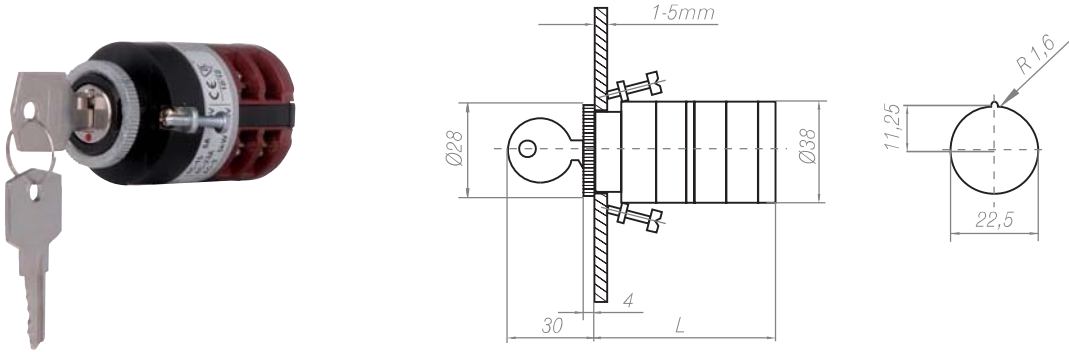

version S9, S10, S11, S12	L (dependent on the number of switching elements)											
	1	2	3	4	5	6	7	8	9	10	11	12
	47	56,5	66	75,5	85	95	104,5	114	123,5	133	143	152,5

S15 SWITCH WITH A SIGNAL LAMP

group A0,A1,A2 version U, OU, PK*)

*protection degree IP52

(Standard colour – red; 220 V).

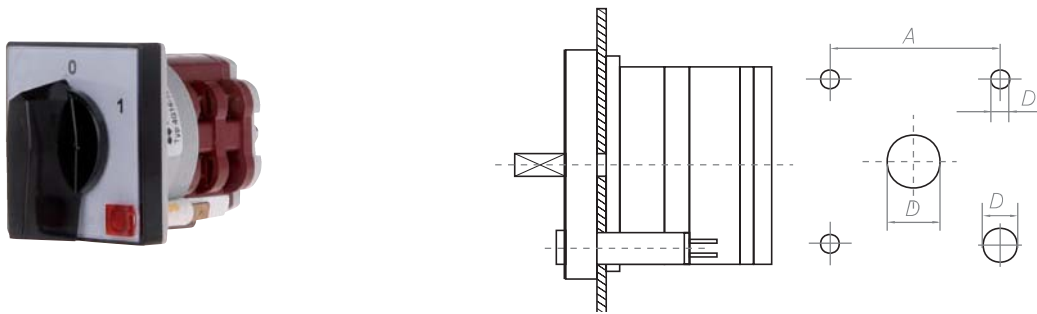

Group	A	D ₁	D ₂	D ₃
	Φ	ø	ø	ø
A0	35	5	14	9
A1	48	5	14	9
A2	72	6	16	9

S18 SWITCH FOR INSTALLATION ON DIN RAIL (ACCORDING TO 35 DIN EN 50022)

group A0, A1, A2 version U

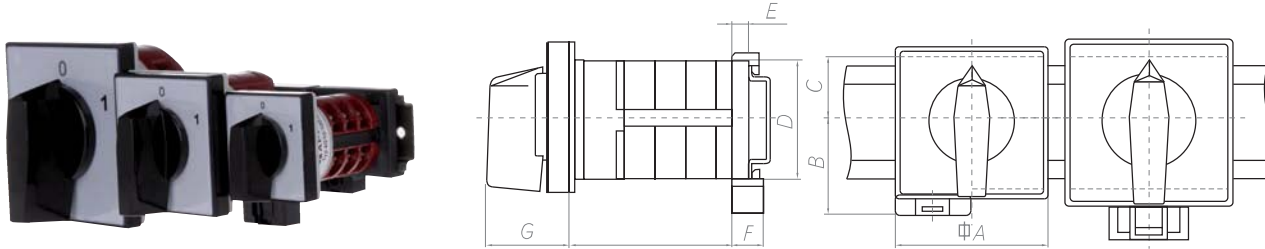

Grupa	A	B	C	D	E	F	G
	Φ						
A0	48	30	21	35	5	10,5	26,5
A1	65	48,5	21	35	9	15	34,5
A2	90	48,5	21	35	9	15	41,5

S19 SWITCH WITH A PROTECTIVE HOUSING (UP TO TWO PACKS)

group A1, A2 version U, OU

Protection to prevent from touching the terminals.

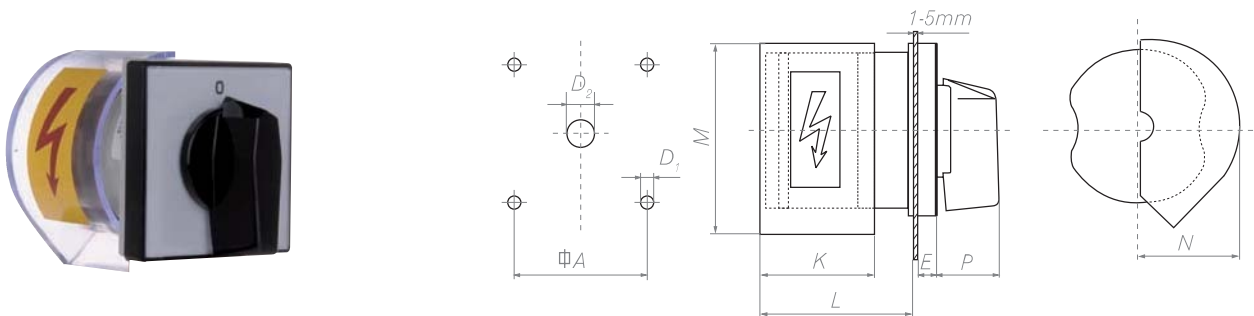

Group	D ₁	D ₂	A	E	P	K	M	N	L
	\emptyset	\emptyset	Φ						
A1	5	14	48	9,5	25	51	78	36	69
A2	6	16	72	9,5	32	58	99	53	78

S21 MAIN SWITCH DISCONNECTOR ACCORDING TO IEC 204 AND VDE 0113

group A1, A2, A3 version U

Black knob, front plate and indicating plate, white markings. Protecting housing like in S19. Blocking lock. Blocking according to order.

S22 EMERGENCY AND MAIN SWITCH DISCONNECTOR (FOR TWO PACKS)

group A1, A2, A3 version U

Red knob, yellow background of an indicating plate, black markings. Protecting housing like in S19. Blocking lock. Blocking according to order.

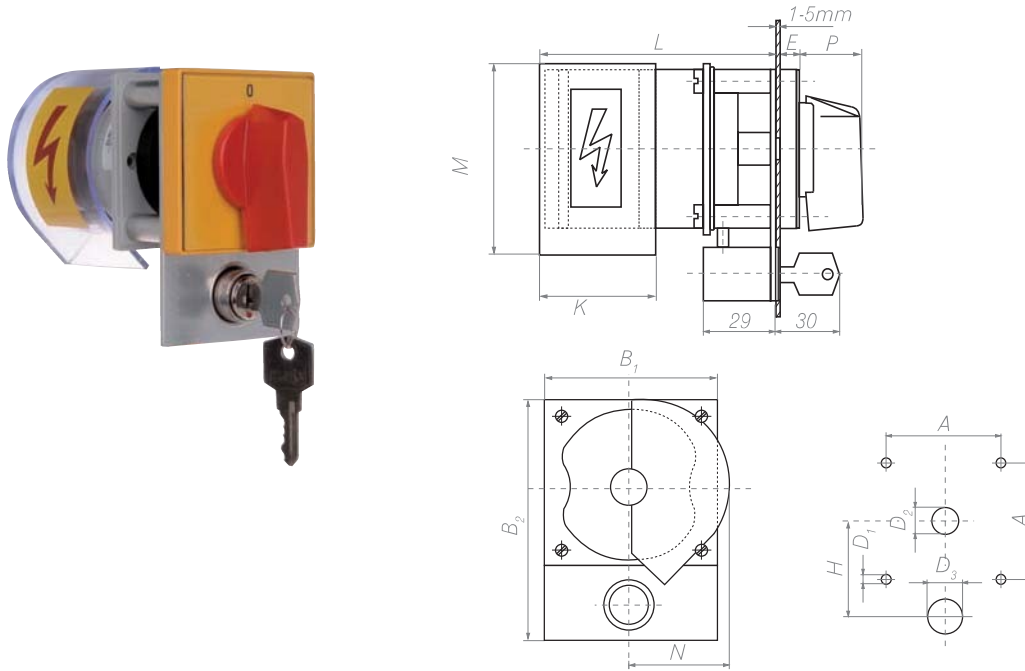

Group	D ₁	D ₂	D ₃	A	B ₁	B ₂	P	K	M	N	L	E	H
	∅	∅	∅										
A1	5	14	21,5	48	65	98	25	51	78	36	95	9,5	48
A2	6	16	21,5	72	90	122	32	58	99	53	104	9,5	60
A3	6	18	21,5	104	132	168	46,5	88	132	78	137	10	85

S24 EMERGENCY SWITCH DISCONNECTOR ACCORDING TO IEC 204 AND VDE 0113

group A1, A2 version U, OU

Red knob, yellow background of an indicating plate, black markings.

The difference between standard and special versions is in different colours of a knob and a plate (red knob, yellow plate, black signs).



S25 MAIN AND EMERGENCY SWITCH DISCONNECTOR (FOR TWO PACKS)

group A1, A2 version U, OU

The blocking position should be specified (red knob, yellow front plate) in the order. Blocking only in 0 position.

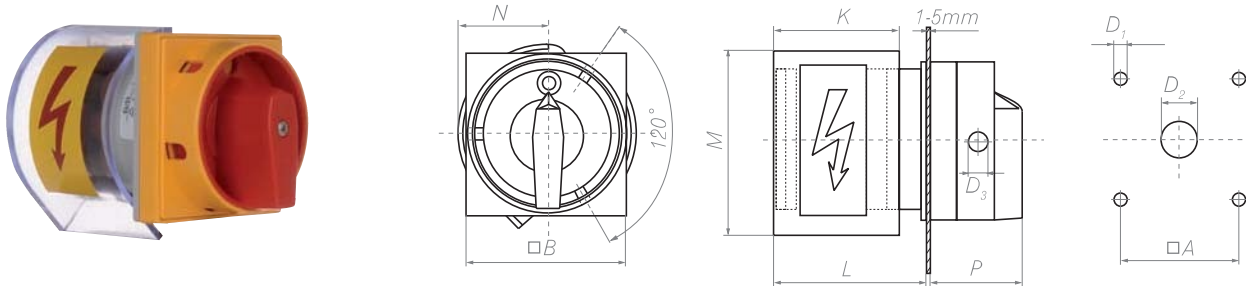

Group	D ₁	D ₂	D ₃	A	B	P	K	M	N	L
	∅	∅	∅	∅	∅					
A1	5	14	7	48	65	35	51	78	36	69
A2	6	16	8	72	90	44	58	99	53	78

S29 SWITCH FOR INSTALLATION IN A Ø22,5 HOLE /IN CONTROL BOARDS/

group A0 version U

The key operates as a knob. Closing in positions 3, 6, 9, 12 /like on a clock/. The key can be removed in the same positions. It is possible to remove the key in the same positions.

S30 SWITCH FOR INSTALLATION IN A Ø30,5 HOLE WITH A FRONT PLATE /IN CONTROL BOARDS/

group A0 version U

The key operates as a knob. Closing in positions 3, 6, 9, 12 /like on a clock/. The key can be removed in the same positions. It is also possible to remove the key in any position.

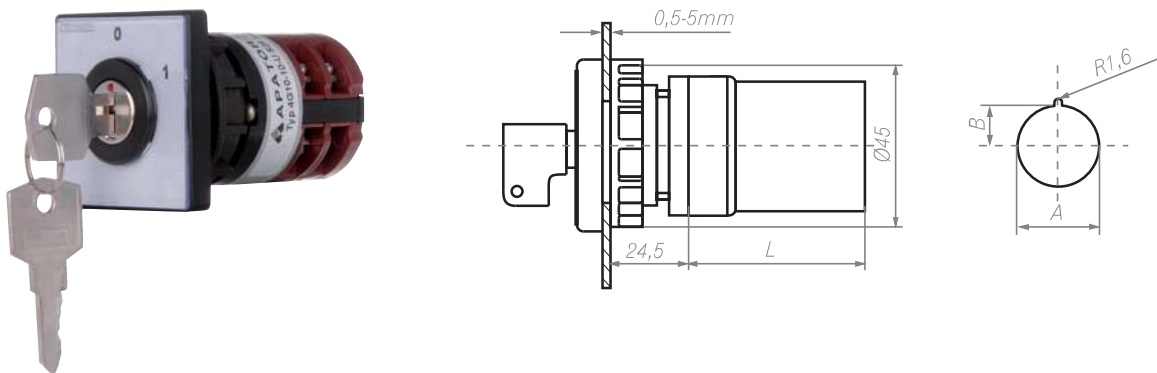

Group	S29	S30
A	22,5	30,5
B	11,25	15,25

The number of the switching elements	1	2	3	4	5	6	7	8	8	10	11	12
L	29	38,5	48	57,5	67	77	86,5	96	105,5	115	125	134



THE CHOICE OF THE MOTOR SWITCHES

Contact life depends on loading conditions. In AC-1 utilization category, where making currents and breaking currents are the same and equal the rated current, the contact life of the switches up to 4G 63 size reaches one million of switching operations.

In more difficult operating conditions the contact life becomes lower. The diagram presented below can be used to make an approximate choice of motor switches, depending on voltage, motor power, number of switching operations per hour and usage class.

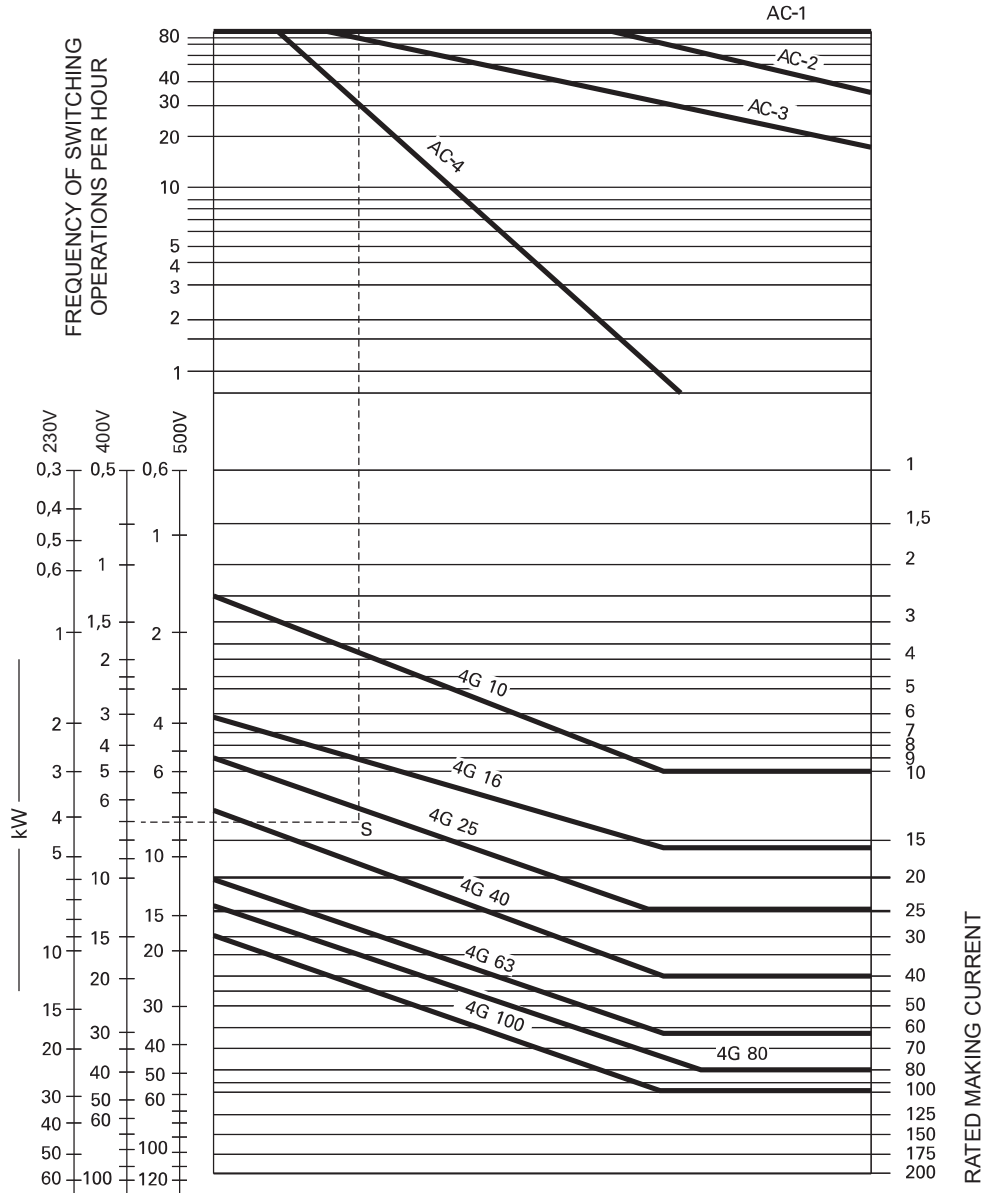

Diagram application example:

The task is to select a cam switch for direct switching and counter-current braking of a squirrel-cage motor characterized by the rated power 7 kW, 380 V and 30 switching operations per hour:

1. Utilization category: AC-4.
2. Find the number of switching operations in the diagram: 30 per hour /in the top part of the diagram/.
3. Draw a horizontal line from the point you have found from the point of intersection with relevant utilization category (AC-4).
4. In the bottom part of the diagram, find the motor power (7 kW, 380 V) on the scale of proper voltage and draw a horizontal line to the right.
5. Draw a perpendicular line down from the point of intersection of the top horizontal line with the utilization category line (AC-4).
6. The point of intersection with the bottom horizontal line "S" lies in the area related to the switch type you are looking for (4G 40).